



Wireless Recorder

Quick Start Guide

Version 1.0.0



T:1.0000.22.xxxx

Packing List

In this document, the Device refers to the wireless recorder.

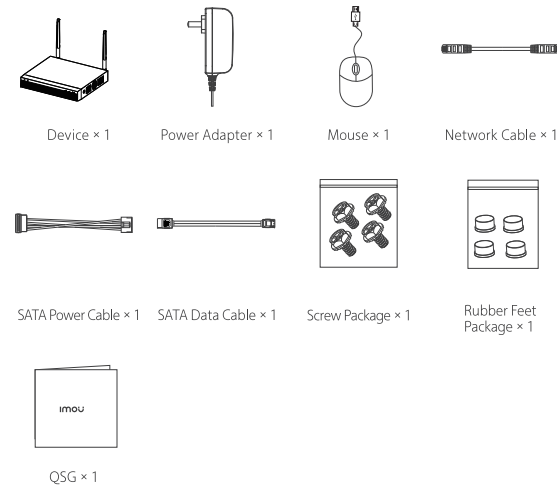

Introduction

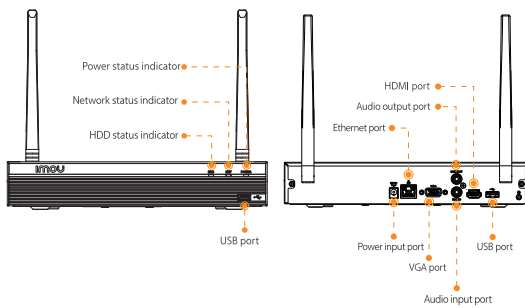

- HDD status indicator off: HDD is working properly
- HDD status indicator always on: HDD is working abnormally
- Network status indicator off: Network connection is normal
- Network status indicator always on: Network connection is abnormal
- Power status indicator always on: Power connection is normal

Installation

Step 1 Unscrew four fixing screws (1,2,3 and 4) of the cover and back them up.

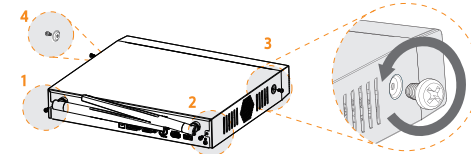

Step 2 Remove the cover in the direction of the arrow as shown in the figure below.

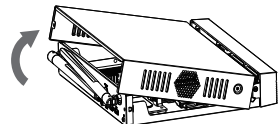

Step 3 Connect HDD to the Device using data cable (a) and power cable (b).

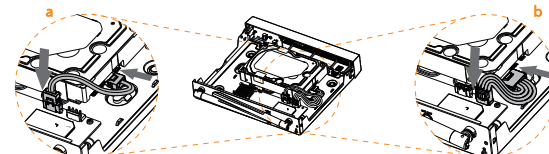

Step 4 Turn over the Device, and align the HDD to the four holes of bottom panel, and then fix the HDD with screws (5, 6, 7 and 8) in the screw package.

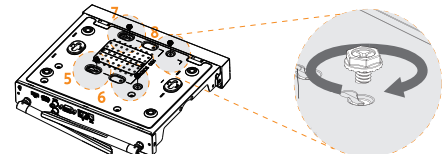

Step 5 Put back and fix the cover with the four backup screws (1, 2, 3 and 4) in Step 1 to finish the installation.

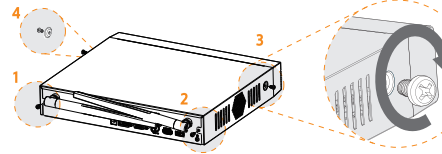

⚠ Turn off the power before opening the cover to replace the HDD, otherwise it might cause damage to the HDD.

Connection

The Device supports wireless connection and wired connection. We recommend that you use wireless connection to connect wireless IPC and to use wired connection when signals are seriously interfered.

- Wireless connection: Put a wireless IPC next to the Device and turn it on, and then turn on the Device later. For details, see **Local Basic Operations**. The wireless IPC will automatically pair to the Device in 120 s. Unplug the power cable of the wireless IPC and install it at a place as needed.

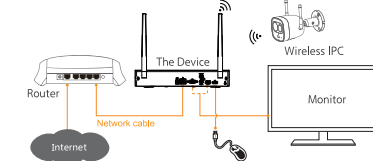

- Wired connection: Add the IPC to the Device according to the **Startup Wizard** when they are turned on.

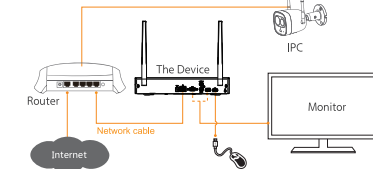

The dotted line in the figures represents a VGA cable or HDMI cable, choose one as needed.

Local Basic Operation

1 Power On and Off

Booting up :

Connect a monitor to the Device, and then plug in the power to boot up the Device.

Shutdown:

Select **Main Menu > SHUTDOWN** to enter the **SHUTDOWN** interface, and then click **Shut down**. Unplug the power after the monitor is blank.

⚠ Do not force the Device to shut down (or unplug the power) when the interface is indicating **Saving data** or the Device is recording videos.

2 Initialization

After turning on the Device for the first time, you need to initialize the Device by the following steps.

- 1) Set parameters for the administrator (the default username is admin).
- 2) Draw an unlock pattern for login.
- 3) Configure the password protection parameters.

📖 Be sure that the email address for resetting password is correct.

3 Startup Wizard

For the first time login, you can configure the Recorder quickly by Startup Wizard, and set options such as general settings, Imou cloud, network settings and record settings.

4 Live View

After you logged in, the system goes to multiple-channel live view mode by default. You can view the live video of each channel.



5 Playback

Select **Main Menu > Search** or right-click on the preview interface and select **Search**. You can play back records according to the configured record type, record time and channel.

App Operation

Step1 Scan the QR code below to install Imou APP. Register and then log in to Imou App.

📖 Ignore Step 1 if you have completed the download and registration of Imou APP in the Startup Wizard.



Step2 Tap **+** at the top-right corner of **Device** tab, and then scan the QR code or enter the serial number of the Device to add it to Imou.

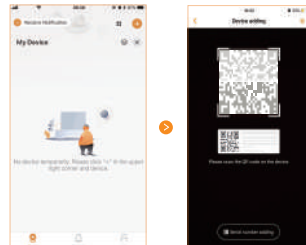

Step3 After adding the Device to Imou, you could perform operations such as viewing live videos, viewing alarms, setting alarm and sharing the Device.

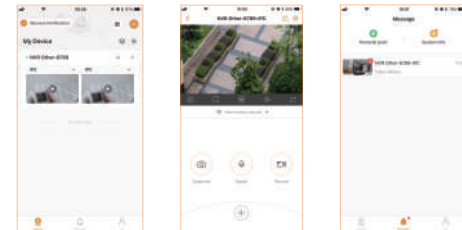

Step4 (Optional) You could share permissions of the Device or a single video channel to family members.

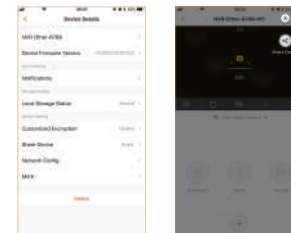

FAQ

Q: Why does the Device fail to boot up?

A: After the Device is powered on, observe the power status indicator on the front panel. If the blue light is off, check the wiring. If the blue light is on and the Device failed to boot up, contact the after-sales service.

Q: How to add a wireless IPC to a running Device?

A: Put the wireless IPC next to the Device and turn it on. Right-click the local GUI and select **Wireless Pairing**. After pairing is completed, install the wireless IPC at a place as needed.

Q: Why are there no video records in local playback?

A: Three possible reasons: 1. Wiring error. 2. HDD malfunction. 3. Record function is not enabled.

Check method:

1. Check the HDD status indicator. If the light is on, the HDD is working abnormally.
2. Select **STORAGE > Disk Check** to run the diagnosis, replace the HDD if there are damages.
3. Right-click the local GUI and select **Manual > Record** to check if the record function is enabled.

Q: Why is the playback time inconsistent with actual time after enabling cloud storage?

A: Ensure that the IPC time is consistent with Device time. Select **SYSTEM > GENERAL > General** to enable IPC Time Sync, you can also select **SYSTEM > GENERAL > Date&Time** to modify Device time.

About the Guide

- This quick start guide is for reference only. Minor difference might be found in user interface.
- All the design and software here are subject to change without prior written notice.
- All trademarks and registered trademarks mentioned are the properties of their respective owners.
- Please visit our website or contact your local service engineer for more information.
- If there is any uncertainty or controversy, please refer to our final explanation.