



Installation & Operation Manual



Download
Manual



Growatt New Energy

Shenzhen Growatt New Energy Co., Ltd
4-13/F, Building A, Sino-German (Europe) Industrial Park,
Hangcheng Ave, Bao'an District, Shenzhen, China

T +86 0755 2747 1942
E service@ginverter.com
W www.ginverter.com
GR-UM-320-A-00

Contents

1 Notes on this manual

- 1.1 Validity
- 1.2 Intended audience
- 1.3 Symbols in this document

2 Safety

- 2.1 Product description and features
- 2.2 Qualified personnel
- 2.3 Safety instruction

3 Product overview

- 3.1 Appearance
- 3.2 Dimensions
- 3.3 Storage environment

4 Inspection upon delivery

5 Installation

- 5.1 Basic installation requirements
- 5.2 Wall-mounted installation
- 5.3 Installing the inverter

6 Electrical connection

- 6.1 Security
- 6.2 AC side wiring
- 6.3 DC side wiring
- 6.4 Connecting the Bidirectional DC/DC Box
- 6.5 Connecting the signal cable
- 6.6 Grounding the inverter
- 6.7 Active power control with a smart meter or a ripple control receiver
- 6.8 Inverter demand response modes (DRMs)
- 6.9 GFCI (Standard)
- 6.10 AFCI (Optional)
- 6.11 Backup function (Optional)

7 Commissioning

8 Working mode

9 OLED display and the touch button

10 Communication and monitoring

11 Maintenance and cleaning

12 Powering on/off the inverter

- 8.1 Operating mode
- 8.2 Failure mode
- 8.3 Shutdown mode

- 9.1 Starting the inverter
- 9.2 General settings
- 9.3 Advanced settings

- 10.1 COM port
- 10.2 USB-A

- 11.1 Checking the heat dissipation
- 11.2 Cleaning the inverter
- 11.3 Checking the DC disconnect

- 12.1 Powering on the inverter
- 12.2 Powering off the inverter

13 Troubleshooting

14 Manufacturer Warranty

15 Decommissioning

16 EU declaration of conformity

17 Specification

18 EU Certificate of Compliance

19 Contact us

- 13.1 Error message
- 13.2 System warning
- 13.3 System error

- 15.1 Removing the inverter
- 15.2 Packing the inverter
- 15.3 Storing the inverter
- 15.4 Disposing of the inverter

1 Notes on this manual

1.1 Validity

This manual is intended to provide product information and installation instructions regarding MID TL3-XH inverters manufactured by Shenzhen Growatt New Energy Co.,Ltd.(hereinafter referred to as Growatt). Please read this manual carefully before using the product. Please note that the content of this manual is subject to change without notice.

MID 11KTL3-XH
 MID 12KTL3-XH
 MID 13KTL3-XH
 MID 15KTL3-XH
 MID 17KTL3-XH
 MID 20KTL3-XH
 MID 25KTL3-XH
 MID 30KTL3-XH

1.2 Intended audience



This manual is intended for professional electricians who possess the required qualifications. Reading through this manual and observing all the precautions, qualified electrical technicians will be able to properly install, configure and troubleshoot the MID TL3-XH series inverters.



Should any questions arise during installation, you can visit www.ginverter.com and leave a message. Or you can call our 24-hour service line at +86 755 2747 1942.

1.3 Symbols in this document











1.3.1 Symbols in this document

Warning notes indicate possible hazards to the equipment or personnel. It calls attention to a procedure which, if not correctly performed or adhered to, could result in damage or destruction of the instrument and personal injury.

Symbol	Description
	DANGER indicates a hazardous situation which, if not avoided, will result in death or serious injury.
	WARNING indicates a hazardous situation which, if not avoided, could result in death or serious injury.

	CAUTION indicates a hazardous situation which, if not avoided, could result in minor or moderate injury.
	NOTICE is used to address practices not related to personal injury.
	Information that you must read and know to ensure optimal operation of the system.

1.3.2 Markings on this product

Symbol	Explanation
	Beware of high voltages
	Beware of fire
	Beware of hot surface
	Delay discharge: observing a waiting time of 5 minutes
	Grounding: indicates the position for connecting the PE cable
	Direct Current (DC)
	Alternating Current (AC)
	Refer to the manual
	CE marking The inverter complies with the requirements of the applicable EU directives
	Do not dispose of the product together with the household waste but in accordance with the disposal regulations for electronic waste applicable at the installation site

1.3.3 Glossary

AC

Abbreviation for "Alternating Current"

DC

Abbreviation for "Direct Current"

Energy

Energy is measured in Wh (watt hours), kWh (kilowatt hours) or MWh (megawatt hours). The energy is power multiplied by time. For example, if the inverter operates at a constant power of 4600 W for 30 minutes and then at a constant power of 2300 W for 30 minutes, it would have generated a total energy output of 3450 Wh in that hour and fed it into the power distribution grid.

Power

Power is measured in W (watts), kW (kilowatts) or MW (megawatts). Power is an instantaneous value. It displays the power that the inverter is currently feeding into the power distribution grid.

Power rate

Power rate is the ratio of current power fed into the power distribution grid and the maximum power of the inverter that can be fed into the power distribution grid.

Power factor

Power factor is the ratio between real power (measured in watts) and apparent power (measured in Volt-Amps). When the current and voltage are in phase, the power factor is 1.0. In an AC circuit, the power is not always equal to the direct product of volts and amperes due to reactive components. In order to find the true power of a single-phase AC circuit, the product of volts and amperes must be multiplied by the power factor.

PV

Abbreviation for photovoltaic.

Wireless communication

The external wireless communication technology is a radio technology that enables communication between the inverter and other communication products. The external wireless communication does not require line of sight between the devices and it is a selective purchasing option.

2.1 Product description and features

2.1.1 Product description

Growatt series hybrid inverters are designed to convert the DC power generated by the PV panels into three-phase AC power and export it to the grid or store the DC power in the batteries. The MID 11-20K TL3-XH series inverters feature 2 maximum power point (MPP) trackers. Each tracker is connected to two PV strings, allowing for the configuration of two PV arrays of different solar panels. The MID 25-30K TL3-XH series inverters feature 3 MPP trackers. Each tracker can be connected to two strings, enabling the configuration of three PV arrays of different solar panels.

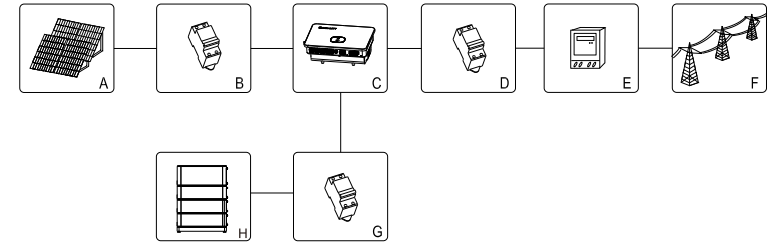

Fig 2.1

Position	Description
A	Solar panel
B	DC circuit breaker
C	Inverter
D	AC circuit breaker
E	Electric energy meter
F	Utility grid
G	DC circuit breaker
H	Battery matched with -XH series inverters

As shown in Fig 2.1 above, a PV Energy Storage System consists of PV modules, the solar inverter, the utility grid and other components, among which the inverter plays a key role.

Note: If the selected photovoltaic module requires positive or negative grounding, please contact Growatt for technical support before installation.

2.1.2 Product features

The inverter features the following highlights:

- Three MPP trackers for MID 25-30K TL3-XH series inverters (Two for MID 11-20K series)
- Built-in DC switch
- Support RS485/Wi-Fi/GPRS/4G communication
- Input voltage range: 160V to 1100V
- 98.0% Max. efficiency
- OLED+LED/WIFI+APP display
- Display options of OLED+LED/Wi-Fi+APP
- Easy operation with the touch button

- IP66 protection
- Lightweight design: 30kg
- Easy installation
- Support energy storage and backup mode, which requires the installation of a backup box
- Integrated with phase-level export limitation function
- Integrated with AC power supply function
- Integrated with energy storage one-key detection function
- Integrated with AC power supply function to realize the 24h self-consumption monitoring

2.2 Qualified personnel

The grid-tied inverter system can only operate properly when correctly connected to the AC distribution network. Before connecting the MID TL3-XH inverter to the power distribution grid, you need to obtain approval from the local utility company. Only qualified and trained technical personnel are allowed to perform the electrical connection.

2.3 Safety instructions



1. Please read this manual carefully before installation. Growatt shall not be liable for any damage caused by failure to follow the instructions and safety precautions specified in this manual.
2. Only professional electricians and mechanical engineers are allowed to perform operations on the inverter and connect cables.
3. When installing the inverter, do not move other parts inside the chassis other than the wiring terminals.
4. All electrical installations must comply with local electrical safety standards.
5. For maintenance services, please contact designated professional personnel in the local area.
6. Before operating the inverter to generate power in grid-tied mode, ensure that you have obtained approval from the local power grid department.
7. When installing PV modules during the day, use opaque materials to cover the modules. Failing to do so can result in high voltage at the terminals, posing a risk to personal safety.

2.3.1 Assembly Warnings



 WARNING	<ul style="list-style-type: none"> ➤ Before installation, please check the unit to ensure that there is no transportation or handling damage, which may affect the insulation integrity or safety clearances; otherwise, it may cause safety hazards. ➤ Follow the instructions in this manual to assemble the inverter. Select a suitable mounting location and comply with the specified requirements of cooling. ➤ Unauthorized removal of necessary protections, improper use, incorrect installation and operation may lead to serious safety and shock hazards and/or equipment damage. ➤ In order to minimize the possibility of shock hazards due to dangerous voltages, cover the entire solar array with dark colored materials before connecting the array to any equipment.
--	---

 CAUTION	<ul style="list-style-type: none"> ➤ Grounding the PV modules: MID TL3-XH inverters are transformerless, meaning that there is no galvanic separation. Do not ground the DC side of the MID TL3-XH inverter, but you need to ground the mounting frame of the PV module. Otherwise, it will report the error message "PV ISO Low". ➤ Comply with the local requirements for grounding the PV modules and the PV generator. GROWATT recommends connecting the generator frame and other electrically conductive surfaces in a manner which ensures continuous conduction with ground in order to have optimal protection of the system and personnel.
---	--

2.3.2 Electrical Connection Warnings

 DANGER	<ul style="list-style-type: none"> ➤ The components in the inverter are live. Touching live components can result in serious injury or death. <ul style="list-style-type: none"> • Do not open the inverter except the junction box. • Only qualified and trained personnel can perform installation, maintenance and replacement. • Forbid live-line work. ➤ Danger to life due to high voltages in the inverter <ul style="list-style-type: none"> • High voltage exists after the inverter is powered off. It takes 20 minutes to discharge to the safe voltage. ➤ Persons with limited physical or mental abilities may only work with the Growatt inverter following proper instruction and under constant supervision. Ensure that the inverter is inaccessible to children.
 WARNING	<ul style="list-style-type: none"> ➤ All electrical connections, such as connecting terminals, the fuse, PE cables, must in compliance with the prevailing regulations. When performing any operations on the inverter while it is powered on, it is important to adhere to all safety regulations to minimize the risk of accidents. ➤ Systems with inverters typically need additional control devices such as switches and disconnects, as well as protective devices like circuit breakers and fuses. The specific type of control and protective devices needed will depend on the relevant safety regulations in effect.

2.3.3 Operation Warnings

 WARNING	<ul style="list-style-type: none"> ➤ Ensure all connectors are sealed and secured during operation. ➤ Although designed to meet all safety requirements, some parts and surfaces of the inverter are still hot during operation. To reduce the risk of injury, do not touch the heat sink at the back of the PV-inverter or nearby surfaces while inverter is operating. ➤ Incorrect sizing of the PV panels may result in high voltages that could damage the inverter. In this case, the inverter will display the error message "PV Voltage High".
 CAUTION	<ul style="list-style-type: none"> ➤ All operations regarding transport, installation and start-up, including maintenance must be operated by qualified, trained personnel and in compliance with all prevailing codes and regulations. ➤ After the system powers off, take great caution as the remaining charge may still cause electrical shocks; to minimize the risk of accidents and damage, follow all safety symbols and markings on the unit and in this manual. ➤ Although standardized emission limit values are in place to minimize interference, certain situations may still result in interference for the specified application area. This can happen when sensitive equipment is located near the setup location, or when the setup location is near radio or television receivers. In these cases, the operator is responsible for taking appropriate measures to resolve the issue. ➤ Keep a safe distance of at least 20cm from the inverter at all times.

Product overview 3

3.1 Appearance

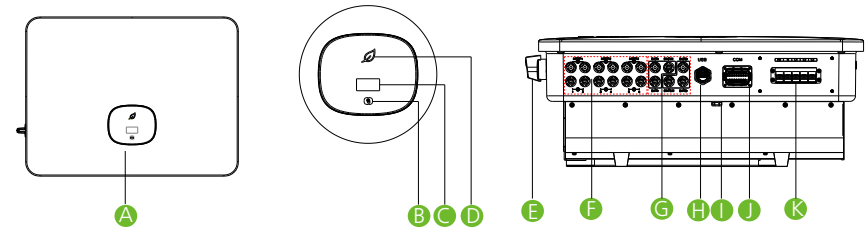



Fig 3.1

Product description:

No.	Component	No.	Component	No.	Component
A	Front panel	E	DC switch	I	Vent valve
B	Touch button	F	PV terminal	J	COM port
C	OLED screen	G	Battery terminal	K	AC terminal
D	LED indicator	H	USB port		

The label description on the inverter:

Symbol	Description	Explanation		
	Touch button	You can switch the interface or set parameters by tapping the button.		
	Inverter status symbol	Inverter status	LED color	LED status
		Standby	Green	0.5S on and 2S off
		Normal	Green	Solid
		Fault	Red	Solid
		Inverter warning/Battery fault	Green	0.5s on, 0.5s off / 0.5s on, 2s off
	Programming	Yellow	1s on and 1s off	

3.2 Dimensions

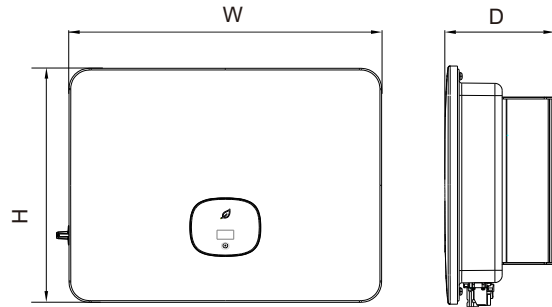

Fig 3.2

Size and weight:

Model	Height (H)	Width (W)	Depth (D)	Weight
MID 11-20KTL3-XH	433mm	579mm	217.5mm	29.5kg
MID 25-30KTL3-XH	433mm	579mm	217.5mm	30kg

3.3 Storage Environment

To store the inverter in a warehouse, choose a suitable location.

- Install the inverter in its original packing materials.
- Keep the storage temperature at -25°C to +60°C and the relative humidity below 90%.
- To store multiple inverters, a maximum of 4 inverters can be stacked.

Inspection upon delivery 4

Before unpacking the inverter, check the outer packing materials for any externally visible damage. After unpacking the inverter, check the scope of delivery for completeness. If the scope of delivery is incomplete or damaged, contact your dealer.

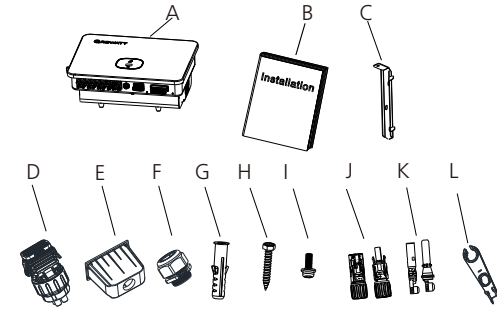

Fig 4.1

No.	Description	Qty.
A	Inverter	1
B	Quick Installation Manual	1
C	Wall-mounting bracket	1
D	COM port connector	1
E	AC waterproof cover	1
F	AC connector shell	1
G	Plastic expansion tube	5
H	Expansion screw	4
I	Security screw	2
J	PV connector	6/6
K	PV metal contact	6/6
L	PV terminal removal tool	1

5 Installation

5.1 Basic installation requirements

- The wall on which the inverter is mounted must be sturdy and can withstand the weight of the inverter for a long time (refer to the specifications in Chapter 17 for the weight of the inverter);
- The installation location should be suitable for the dimensions of the inverter;
- Do not install the inverter in areas with flammable or thermolabile materials;
- Install the inverter in an appropriate place for the user's ease to view and operate on the display;
- The inverter is protected to IP66 and can be installed indoors and outdoors;
- The mounting location cannot be exposed to direct solar irradiation, which may cause overheating. As a result, the inverter reduces its power output;
- Keep the relative humidity at 0 to 90%;
- Keep the ambient temperature at -25°C to +60°C;
- Install the inverter vertically or at a maximum back tilt of 15 degrees. Do not install the inverter at a front tilt, horizontally, or upside down.

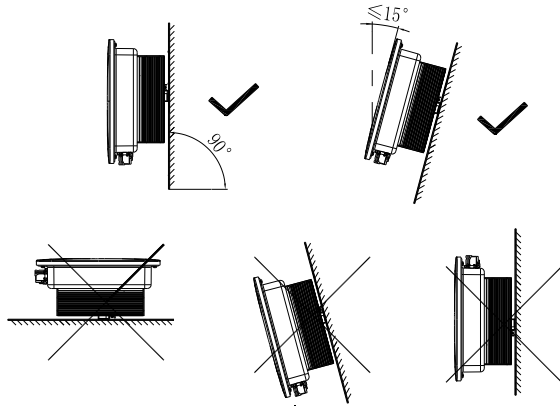

Fig 5.1 Installation diagram

- For the optimal operation of the equipment and the convenience of operation, please reserve enough clearances around the inverter. The minimum clearances are listed below:

Direction	Minimum clearance (mm)
Top	500
Bottom	500
Both sides	300
Front	300

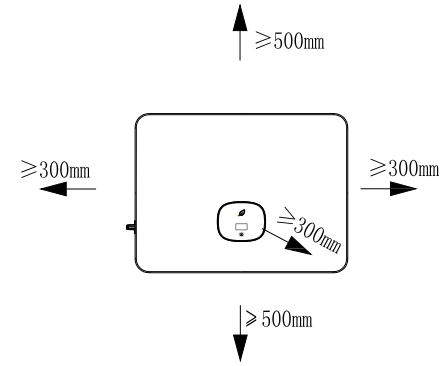

Fig 5.2 Clearance requirements for a single inverter

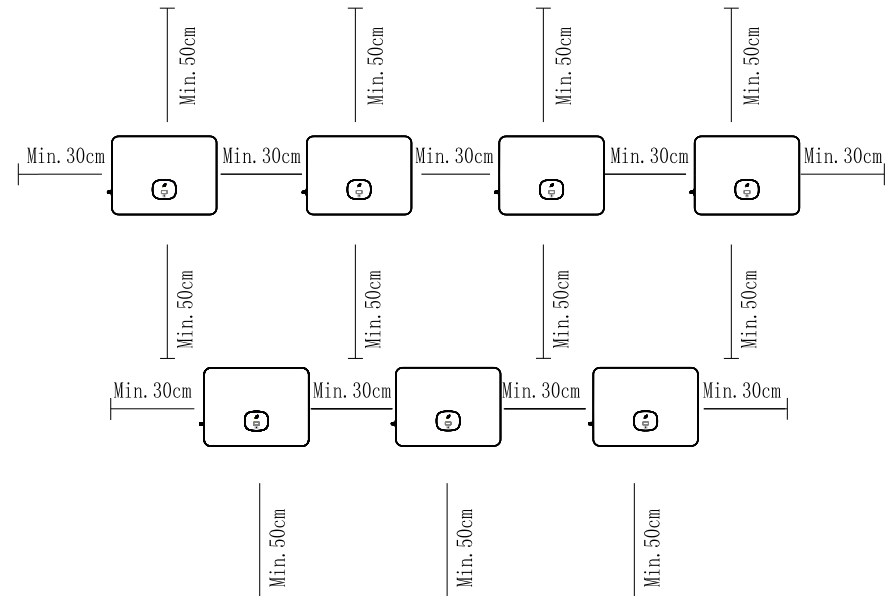

Fig 5.3 Clearance requirements for multiple inverters

- Do not install the inverter near the television antenna or any other antennas and antenna cables;
- Do not install the inverter in the living area;
- The mounting location must be inaccessible to children;
- Protect the inverter against direct sunlight and rain by installing a shelter or an awning.

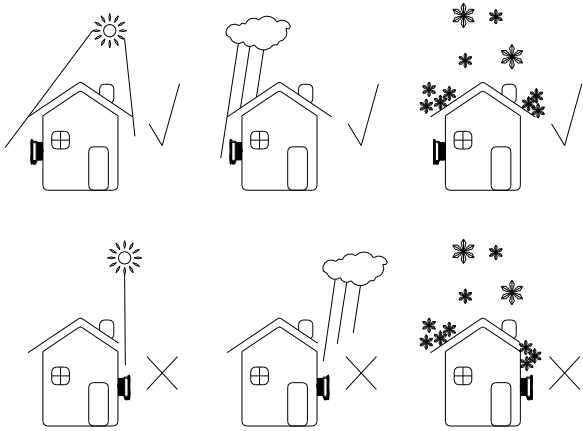

Fig 5.4 Installation Environment

- It is not allowed to install or operate the inverter in a sealed box.

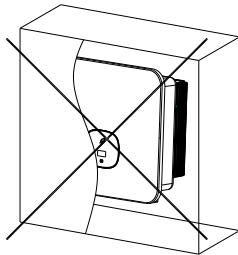

Fig 5.5 Closed box

- It is recommended to install an awning over the inverter to extend its service life. The distance requirements between the awning and the inverter are as follows:

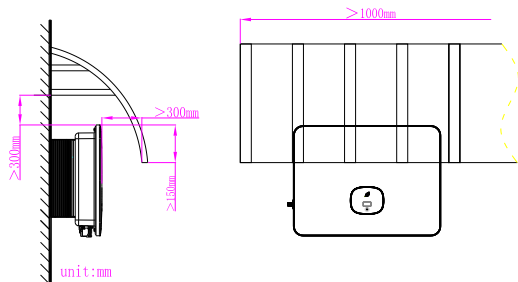

Fig 5.6 Awning

5.2 Wall-mounted installation

5.2.1 Installing the wall-mounting bracket

	<p>For safety reason, avoid water pipes and power cables when drilling holes.</p>
--	---

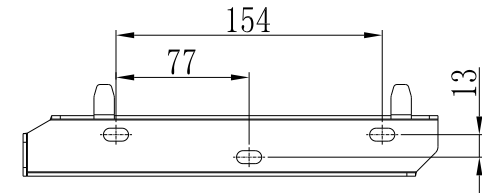

Fig 5.7 Dimensions of the wall-mounting bracket

Fix the mounting bracket as the figure shows. The screws should not be fully flush when inserted. Instead, leave 2 to 4mm of the screw exposed.

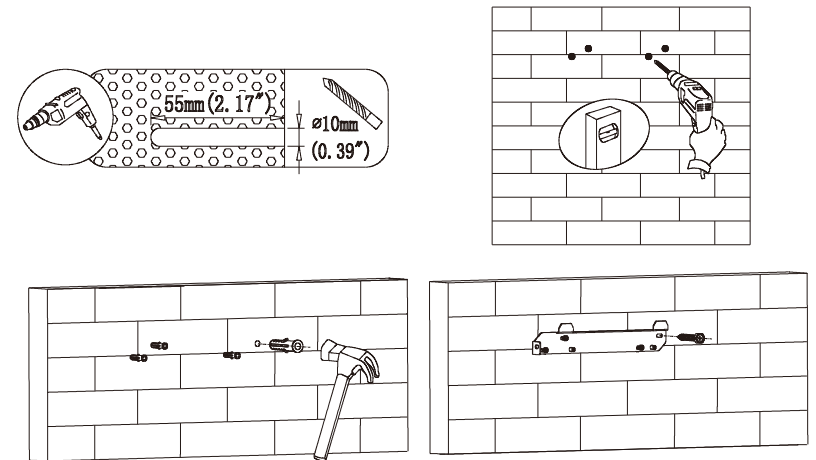

Fig 5.8 Installing the wall-mounting bracket

5.3 Installing the inverter

Note: Before installing the inverter, ensure that the wall-mounting bracket is securely installed.

Follow the steps to install the inverter:

1. Place the inverter on the bracket and keep balance when moving the inverter.
2. To fix the inverter to the wall, tighten the M5 safety locking screw on the left.

Electrical connection 6

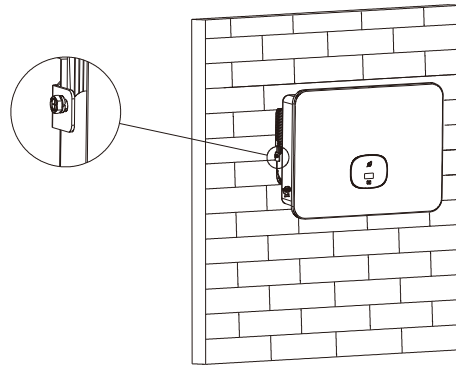







Fig 5.9 Installing the inverter

6.1 Security

 Danger	<p>High voltages in the conductive parts of a running inverter may cause electric shocks. Therefore, ensure that the inverter is disconnected from voltage sources and is not powered on before starting installation</p>
 Warning	<p>Static electricity may damage the electronic components of the inverter. Anti-static measures should be taken during the replacement or installation of the inverter.</p>
 Note	<p>Moisture and dust penetration can damage the inverter</p> <ul style="list-style-type: none"> ➤ Make sure that the waterproof cable gland is firmly tightened. ➤ If the cable connector is not installed correctly, the inverter may be damaged due to the penetration of moisture and dust. In this case, all warranties shall be void.

6.2 AC side wiring

 Danger	<p>Before connecting cables, ensure that the DC switch of the inverter is off and disconnect the AC circuit breaker. Otherwise, high voltages may cause electric shocks, resulting in serious injury or death from inverter in operation.</p>
 Warning	<ul style="list-style-type: none"> ➤ In PV system with multiple inverters, protect each inverter with a separate circuit breaker. ➤ Do not use the single-core wire to connect the output terminal of the inverter. ➤ Do not use aluminum wires as the output cables. ➤ Ensure that the AC output cable is securely connected before powering on the inverter. Failure to follow the safety precautions may cause device and property damage, which is beyond the warranty scope.
 Note	<p>Moisture and dust penetration can damage the inverter.</p> <ul style="list-style-type: none"> ➤ Make sure the cable connector is securely tightened. ➤ If the cable connector is not installed correctly, the inverter may be damaged by moisture and dust. In these cases, all warranty claims shall be void.

You must install a separate three phase circuit-breaker or other load disconnection unit for each inverter in order to ensure that the inverter can be safely disconnected under load.

The recommended AC circuit breaker specifications are shown below:

Inverter model	Switch specification
MID 11KTL3-XH	25A(230/400V)
MID 12KTL3-XH	25A(230/400V)
MID 13KTL3-XH	30A(230/400V)
MID 15KTL3-XH	30A(230/400V)
MID 17KTL3-XH	35A(230/400V)
MID 20KTL3-XH	40A(230/400V)
MID 25KTL3-XH	40A(230/400V)
MID 30KTL3-XH	50A(230/400V)

Residual current protection device (RCMU)
 As the inverter is equipped with a highly accurate residual current detection device, it is not recommended to install a leakage protection switch. If an external residual-current device is required, install a Type-A leakage protection switch that trips at a residual current of 300 mA or higher and install it between the inverter and the grid. When multiple leakage protection switches are installed, do not connect them to a shared neutral line. Otherwise, the leakage protection function may be triggered by mistake.

AC connection:

1. Route the five wires (A, B, C, N, PE wires) through the AC protective cover; crimp the ring or spade terminals; then connect them to the screw terminals on the AC connector.

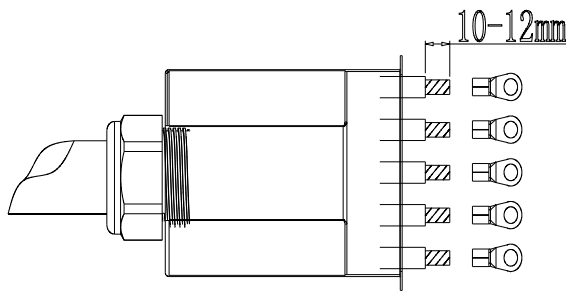

Fig 6.2 Crimping the AC output cable and terminal lugs

2. Connect the AC cable to the corresponding AC terminal.

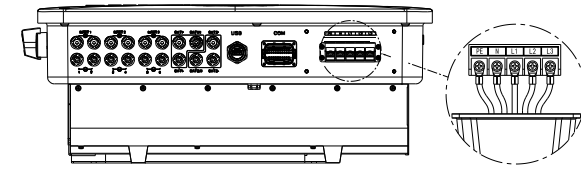

Fig 6.3 Connecting the AC output power cable

3. Secure the protective cover onto the inverter and tighten the screw on the protective cover.

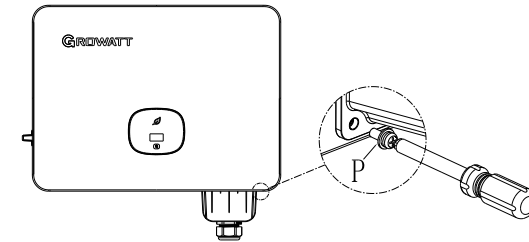



Fig 6.4 Installing the waterproof cover

Recommended cable specifications:



Model	Cross-section area (Cu)	Maximum cable length
MID 11-20KTL3-XH	10-12mm ²	40m
MID 25-30KTL3-XH	14-16mm ²	40m

6.3 DC side wiring



Danger

- The PV panel will generate voltage with solar irradiation. High voltages may occur when the panels are connected in serials, which can result in personal injury. Therefore, cover the panels with opaque materials before connecting the DC input cable and ensure that the DC switch is off.
- To avoid electric shock, do not touch the live parts, and connect the terminals carefully.
- Please make sure that the AC switch has been disconnected before wiring.

 Warning	<p>Please ensure that the following conditions are met, otherwise it may cause a fire hazard or damage the inverter. In this case, Growatt shall not be liable for any consequence.</p> <ul style="list-style-type: none"> ➢ The maximum open circuit voltage of each string of photovoltaic modules shall not exceed 1000Vdc under any conditions. ➢ PV modules connected in series in each PV string should be of the same specification type. ➢ The maximum short-circuit current of each PV string must not exceed 26A under any conditions. ➢ The total output power of all PV strings must not exceed the maximum input power of the inverter. ➢ The negative port of the PV panel mustn't be grounded when there is no isolation transformer (the inverter output is connected to the grid directly). ➢ If a stable non-zero DC voltage is detected between the positive pole of the photovoltaic string and the ground, it means that an insulation fault has occurred at a certain position in the photovoltaic string. You need to ensure that the fault is rectified before continuing the wiring.
 Note	<p>Moisture and dust penetration can damage the inverter.</p> <ul style="list-style-type: none"> ➢ Make sure that the waterproof cable gland is firmly tightened. ➢ If the cable connector is not installed correctly, the inverter may be damaged due to the penetration of moisture and dust. In this case, all warranties shall be void.

The MID 11-20KTL3-XH inverters have two independent inputs, and the MID 25-30KTL3-XH inverters have three inputs.

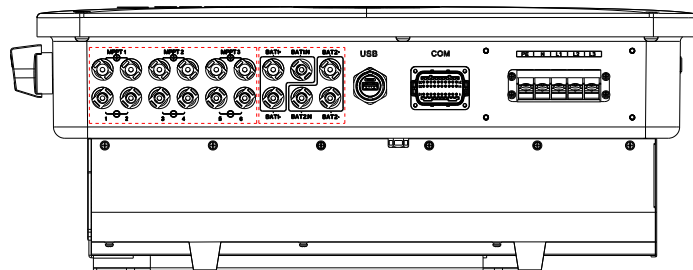



Fig 6.5

When installing the PV modules, please note that:

- The PV modules in each PV string should be of the same specifications and model.
- Each PV string should have the same number of PV modules connected in series.

 Note	<ul style="list-style-type: none"> ➢ Before connecting to the PV panel, ensure the correct polarity. Connect the positive and negative terminals of a PV module to the positive and negative DC input terminals of the inverter respectively. ➢ The maximum DC input current and voltage of the inverter shall not exceed the following limits. 		
	Model	Max. input current per MPPT	Maximum input voltage
	MID 11-20KTL3-XH	32A/32A	1100V
MID 25-30KTL3-XH	32A/32A/32A	1100V	

Connect DC terminal

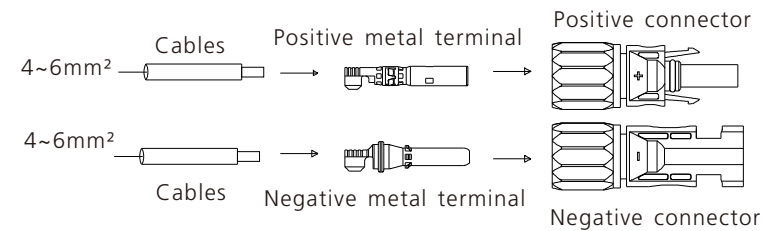

Fig 6.6

6.4 Connecting the Bidirectional DC/DC Box

6.4.1 Conditions for Bidirectional DC/DC Box

The MID 11-30KTL3-XH three-phase inverters feature two independent BAT inputs: the BAT+/BAT- terminal can be connected to a Bidirectional DC/DC Box.

Please note that the connectors used are paired male and female connectors. The connectors for the Bidirectional DC/DC Box and the inverter are Helios H4-R/VP-D4/MC4 connectors.

The Bidirectional DC/DC Box is used to work with the inverter to manage the battery's charging and discharging mode.

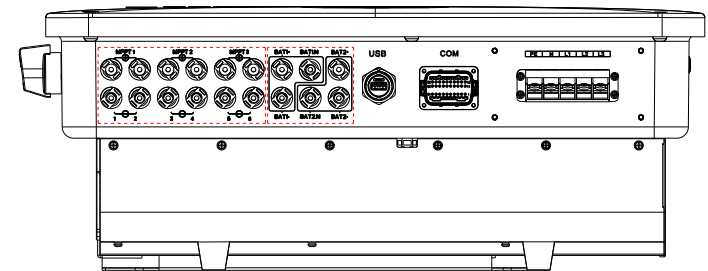



Fig 6.7

6.4.2 Connecting the Bidirectional DC/DC Box

 DANGER	<p>Danger to life due to lethal voltages! Before connecting the Bidirectional DC/DC Box, ensure that the Box is disconnected from any power supply. NEVER connect or disconnect the BAT connectors under load. Ensure the correct polarity when connecting the Bidirectional DC/DC Box to the inverter.</p>
 WARNING	<p>Improper operation during the wiring process can cause fatal injury to the operator or unrecoverable damage to the inverter. Only qualified personnel can perform the wiring work.</p>

Connecting the BAT input terminals

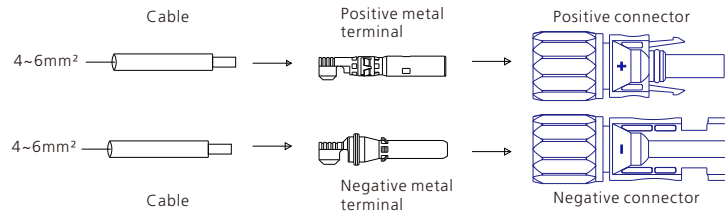

Fig 6.8

6.5 Connecting the signal cable

The MID series inverter is equipped with a 30-Pin signal connector, except for Vietnam models. Please refer to Section 10.1 for details. The port connected to the client-side signal cable is shown below:

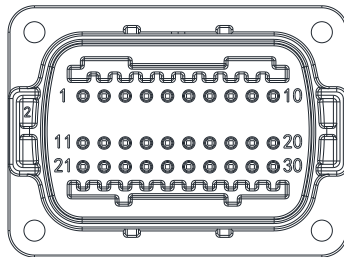

Fig 6.9

1.Strip the cable by 10mm and pass it through the waterproof gland and the threaded sleeve, then tighten the screws.

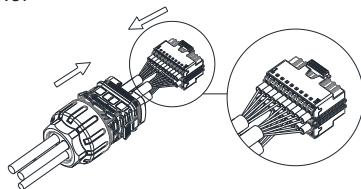

Fig 6.10

2.Connect the client-side to the port on the inverter and ensure that they are securely connected.

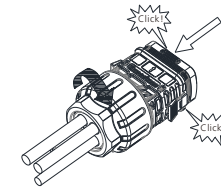

Fig 6.11

Removing the signal connector

1.Press down the fastener and pull it out from the inverter.

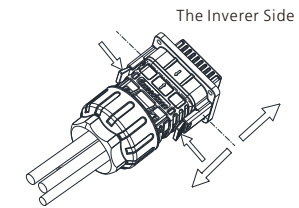

Fig 6.12

6.6 Grounding the inverter

The inverter must be connected to the AC grounding conductor of the power distribution grid through the ground terminal (PE) .



WARNING

Because of the transformerless design, the DC positive pole and DC negative pole of PV arrays are not permitted to be grounded. This inverter complies with IEC 62109-2 clause 13.9 for earth fault alarm monitoring.
 If an Earth Fault Alarm occurs, the fault code "Error 303, NE abnormal" will be displayed on the inverter screen while the LED indicator will turn red. (Applicable to inverters with graphical display only)

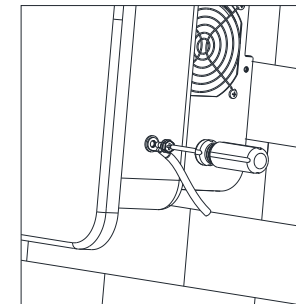



Fig 6.13

In accordance with the regulations outline in IEC 61643-32 "Surge protective devices connected to the d.c. side of photovoltaic installations - Selection and application principles.", it is essential to implement lightning protection measures for both household and commercial photovoltaic power plants.

 WARNING	<p>The lightning protection measures for photovoltaic systems shall be carried out in accordance with the corresponding national standards and IEC standards. Otherwise, photovoltaic devices such as components, inverters and power distribution facilities may be damaged by lightning.</p> <p>In this case, Growatt shall not be liable for the consequence and the damage is not covered by warranty.</p>
---	--

6.7 Active power control with a smart meter or a ripple control receiver

 Information	<ul style="list-style-type: none"> ➤ The smart meter should be installed between the inverter and the grid. ➤ For details about the meter wiring, please refer to the manual of the smart meter.
---	--

Inverters of this series support the export limitation functionality. To enable this function, you can install a Growatt smart meter. For details, please contact Growatt support.

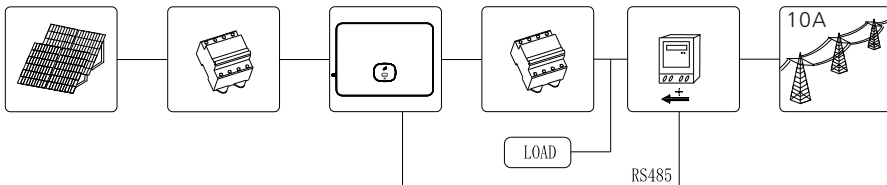

Fig 6.14

Smart meter models		
No.	Meter Brand	Meter Pin No.
1	Chint	24,RS485A/25,RS485B
2	Eastron	A,RS485A/B,RS485B
3	Growatt	A,RS485A/B,RS485B

Manufacturer	Eastron
Type	SDM630CT-Modbus V3
General Specifications	
Voltage AC (Un)	3*230V
Voltage Range	184~299V AC

Base Current (Ib)	10A
Power consumption	≤2W
Frequency	50/ 60Hz(±10%)
AC voltage withstand	4KV for 1 minute
Impulse voltage withstand	6KV-1.2uS waveform
Overcurrent withstand	20I _{max} for 0.5s
Pulse output 1	1000imp/kWh (default)
Pulse output 2	400imp/kWh
Display Max. Reading	LCD with white backlit 999999kWh
Environment	
Operating temperature	-25°Cto +55°C
Storage and transportation temperature	-40°Cto +70°C
Reference temperature	23°C ±2°C
Relative humidity	0 to 95%, non-condensing
Altitude	up to 2000m
Warm up time	3s
Installation category	CAT II
Mechanical Environment	M1
Electromagnetic environment	E2
Degree of pollution	2
Mechanics	
Din rail dimensions	72x66x100 (WxHxD) DIN 43880
Mounting	DIN rail 35mm
Ingress protection	IP51 (indoor)
Material	self-extinguishing UL94V-0

Active power control with a Radio Ripple Control Receiver (RRCR).

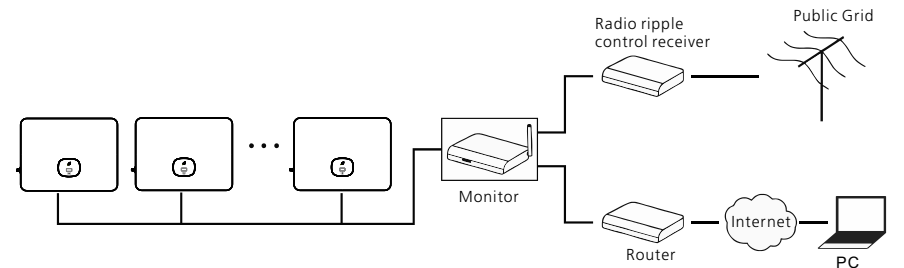





Fig 6.15

6.8 Inverter demand response modes (DRMs)

Inverters of this series feature the demand response modes and use a 16-pin socket as the DRMs connector.

 Information	<p>DRMs application description</p> <ul style="list-style-type: none"> ➤ Applicable to AS/NZS4777.2:2015 or Commission Regulation (EU) 2016/631. ➤ DRM0, DRM5, DRM6, DRM7, DRM8 are available.
 CAUTION	<p>Damage to the inverter due to moisture and dust penetration</p> <ul style="list-style-type: none"> ➤ Make sure the cable glands have been tightened firmly. ➤ If the cable glands are not mounted properly, the inverter can be destroyed due to moisture and dust penetration. In this case, all the warranties shall be void.
 WARNING	<p>Excessive voltage can damage the inverter! External voltage of DRM PORT don't over +5V.</p>

6.8.1 16-Pin socket pin assignment

No.	Description	Remarks
11	DRM1/5	Relay contact 1 input
12	DRM2/6	Relay contact 2 input
13	DRM3/7	Relay contact 3 input
14	DRM4/8	Relay contact 4 input
15	REF/GEN	GND
16	DRM0/COM	/

6.8.2 Method of asserting demand response modes

Mode	Socket asserted by shorting pins		Function
	Pin 11	Pin 15	
DRM 0	16	15	Operate the disconnection device.
DRM 5	11	15	Do not generate power.
DRM 6	12	15	Do not generate at more than 50% of rated power.
DRM 7	13	15	Do not generate at more than 75% of rated power and sink reactive power if capable.
DRM 8	14	15	Increase power generation (subject to constraints from other active DRMs).

6.8.3 Using the Power Control Interface for EU models

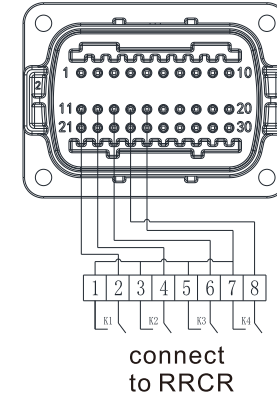

Fig 6.16 Inverter – RRCR Connection

6.8.3.1 The following table describes the connector pin assignment and function:

DRM Socket Pin NO.	Description	Connect to RRCR
11	Relay contact 1 input	K1 – Relay 1 output
12	Relay contact 2 input	K2 – Relay 2 output
13	Relay contact 3 input	K3 – Relay 3 output
14	Relay contact 4 input	K4 – Relay 4 output
15	GND	Relays common node

6.8.3.2 The inverter is preconfigured to the following RRCR power levels:

DRM Socket Pin 11	DRM Socket Pin 12	DRM Socket Pin 13	DRM Socket Pin 14	Active power	Cos(φ)
Shorting with Pin 15				0%	1
	Shorting with Pin 15			30%	1
		Shorting with Pin 15		60%	1
			Shorting with Pin 15	100%	1

Active power control and reactive power control are enabled separately.

6.9 GFCI (Standard)

6.9.1 Ground fault circuit interrupter (GFCI)

The inverter is equipped with a residual-current device. When the leakage current is over 300 mA and lasts for over 300 ms, the inverter will report Fault 201 and displays "Residual I High".

The inverter features the function of detecting residual current and protecting the inverter against residual current. If you need to install an external AC breaker which supports residual current detection, you are advised to install a Type A RCD breaker with the rated residual current greater than 300 mA.

6.10 AFCI (Optional)

6.10.1 Arc-Fault Circuit Interrupter (AFCI)

In accordance with the National Electrical Code R, Article 690.11, the inverter has a system for the recognition of electric arc detection and interruption. An electric arc with a power of 300 W or greater must be interrupted by the AFCI within the time specified by UL 1699B. A tripped AFCI can only be reset manually. You can deactivate the automatic arc fault detection and interruption (AFCI) via a communication product in "Installer" mode if you do not require the function. The 2011 edition of the National Electrical Code R, Section 690.11 stipulates that newly installed PV systems attached to a building must be fitted with a means of detecting and disconnecting serial electric arcs (AFCI) on the PV side.

6.10.2 Danger information



Be aware of fire caused by the electric arc
Only test the AFCI for false tripping in the order described below.
Do not deactivate the AFCI permanently.

If the "Error 200" message is displayed and the buzzer alarms, it indicates that an electric arc has occurred in the PV system. The AFCI will be tripped, and the inverter is in a permanent shutdown state. The inverter has significant electrical potential differences between its conductors, which can result in arc flashes when high-voltage current flows. Please do not perform operations on an inverter in operation. The inverter has large electrical potential differences between its conductors. Arc flashes can occur through air when high-voltage current flows. Do not work on the product during operation.

When the inverter reports Error 200, please perform the following steps:

6.10.3 Operation step

6.10.3.1 Turn the DC & AC Switch to the position "OFF".

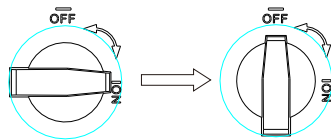

Fig 6.17

Wait until the screen is off.

6.10.3.2 Perform troubleshooting on the PV system:

Check if the open-circuit voltage of the PV strings is within the permissible range.

6.10.3.3 After the fault is rectified, restart the inverter:

Turn the DC & AC Switch to the position "ON".

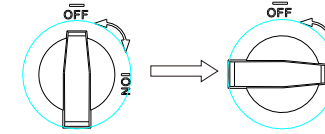

Fig 6.18

6.11 Backup function (Optional)

The MID-XH series inverters can work in backup mode. In this mode, the inverter can output power of 230/400 V, 50/60 Hz to the load when the grid goes down. To enable this mode, you need to install a backup box. The system diagram is shown below:

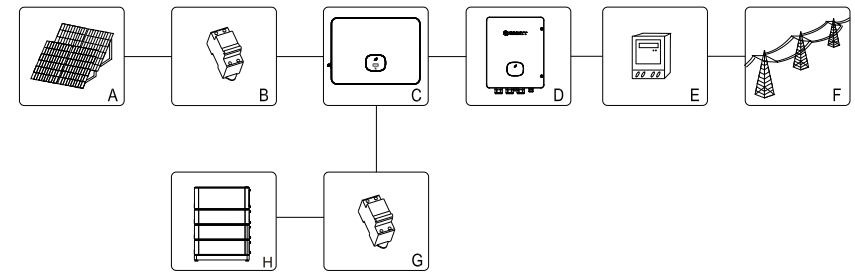

Fig 6.19

COM Port	XH Inverter COM	SYN 100-XH-30 COM (Contral Board Cn8)
RS 485 A	PIN23	PIN3
RS 485 B	PIN24	PIN4
BOX.EN+	PIN21	PIN5
BOX.EN-	PIN22	PIN6

As shown in Fig 6.19, the PV energy storage system comprises PV panels, the inverter, the backup box, the utility grid and other components, among which the inverter plays a crucial role. To enable the backup mode, please refer to Section 9.3.3 Setting the backup mode.

Note:

1. When the grid goes down, the max. output power of a fully charged battery reaches 30kW.
2. Only professional personnel are allowed to configure the backup mode. To enable the backup mode, you need to purchase a backup box from Growatt.

7 Commissioning

1. Turn on the DC switch on the inverter. Once the input DC voltage is greater than 160V, the inverter will display "No AC connection" and the LED indicator will turn red. If other error message is displayed, please refer to Section 13. If you encounter any technical problems, please contact Growatt support.
2. Turn on the circuit breaker or the switch between the inverter and the grid, the inverter will start a countdown to perform a self-check. If no fault is found, the inverter will be connected to the grid.
3. When the inverter is working properly, the leaf-shape indicator will turn green.
4. Finish the commissioning process.

8 Working Mode

8.1 Operating mode

In this mode, the inverter works normally.

- When the grid-connected requirements are met - the DC voltage is greater than 200V, and the grid voltage and frequency are within the permissible range, the inverter will convert the DC power generated by the solar panels into AC power and feeds it to the grid with the green LED indicator on.
- When the DC voltage falls below 160V, the inverter will automatically disconnect from the grid and exit the operating mode. It will enter the operating mode and be connected to the grid automatically once the requirements are met.

8.2 Failure mode

When an unexpected condition occurs, such as a system failure or an inverter failure, the inverter will report the error message on the screen. In failure mode, the leaf-shape indicator will turn red and the inverter will be disconnected from the grid.

8.3 Shutdown mode

When PV power is insufficient or no PV power is generated, the inverter will shut down automatically. In shutdown mode, the inverter does not consume energy from the grid or the solar panels, and the display and the indicators will be off.

OLED display and the touch button 9

The OLED display shows the running status of the inverter. You can switch the interface and set related parameters by tapping the touch button.

9.1 Starting the inverter

9.1.1 Touch control

Symbol	Description	Explanation	
	Touch button	Single tap	Switch the display interface or increase the value by one
		Double tap	Assess the settings or confirm your setting
		Tripple tap	Return to the previous interface
		Long press for 5s	Restore the default value

9.1.2 Set Country/Area



Information

Country setting

For the device to begin operation, a country data set must be configured correctly. If no country data set is configured in 30s, it will operate according to the default value: AS/NZS477.2 for Australia and VDE0126-1-1 for other regions.

When the inverter initializes, the OLED screen lights up automatically. Once the PV power is sufficient, it will display "PV Inverter". Tap the touch button to scroll through the country options until the desired selection is displayed. For instance, to select Germany, tap the touch button until "VDE0126" is displayed; long press the button for 5s and the screen will indicate that the configuration is completed.

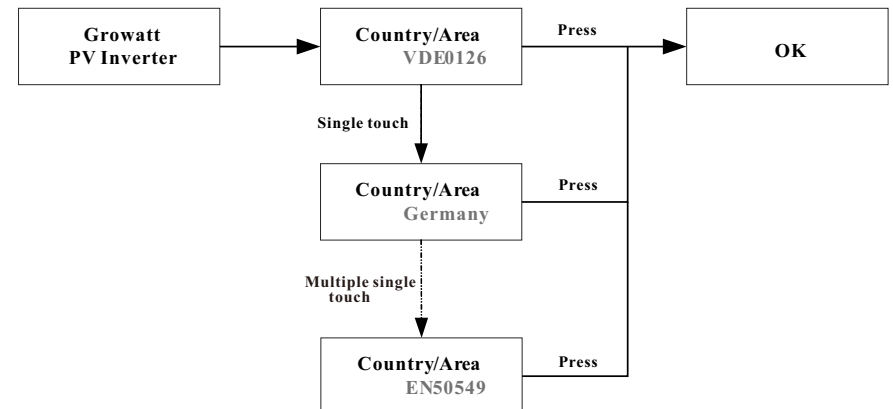

9.2 General settings

9.2.1 Setting the display language

Multiple language options are available for this series inverter. Single tap to view different options; double tap to confirm your setting. Set the language as shown below:

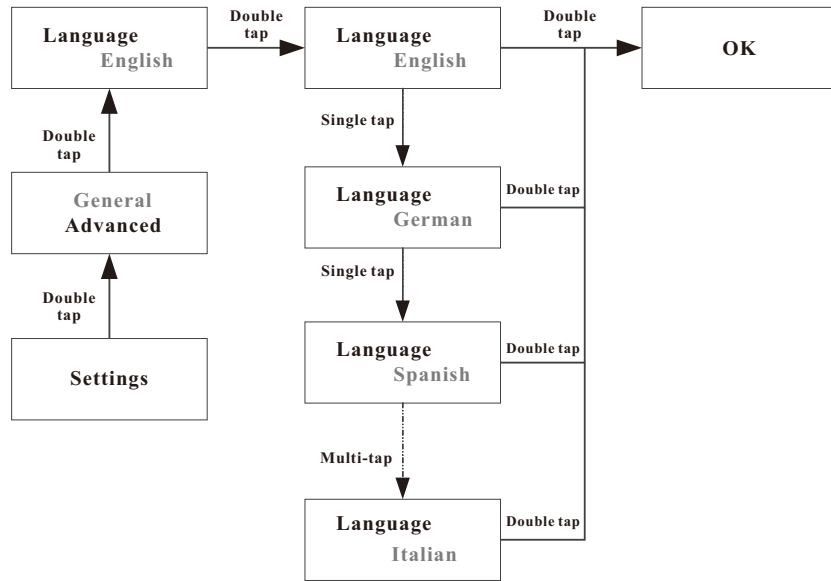

9.2.3 Setting the date

Single tap to increase the number by one; double tap to confirm your setting. Set the date as shown below:

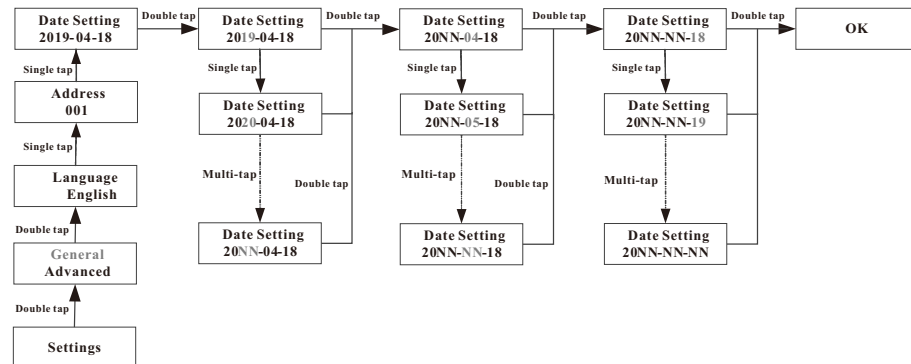

9.2.4 Setting the time

Single tap to increase the number by one; double tap to confirm your setting. Set the time as shown below:

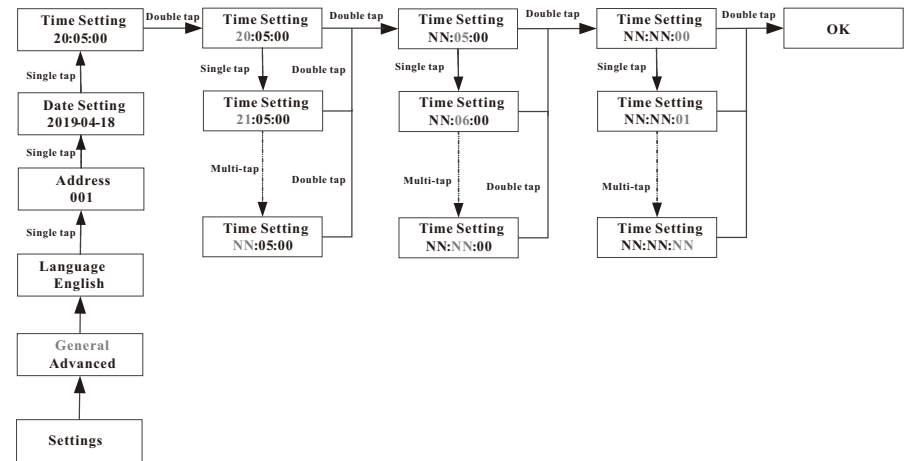

9.3 Advanced settings

Single tap to scroll through the options or increase the number by one; double tap to confirm your settings. The password for advanced settings is 123. After entering the password, you can change the Country/Area setting and the PQR settings.

Reset Country

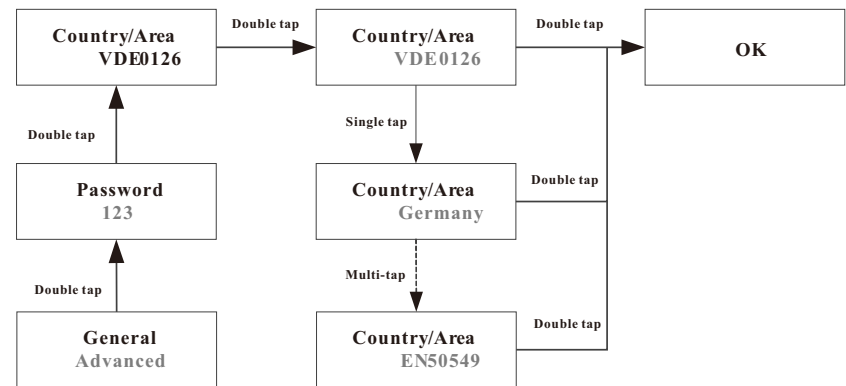

9.3.1 Setting the export limitation parameter

The -XH series inverters supports the export limitation function when working with an external power meter or CT. Users can configure the parameter on the OLED screen. Single tap to view the options available or increase the number by one; double tap to confirm your setting. Set the export limitation parameter as shown below:

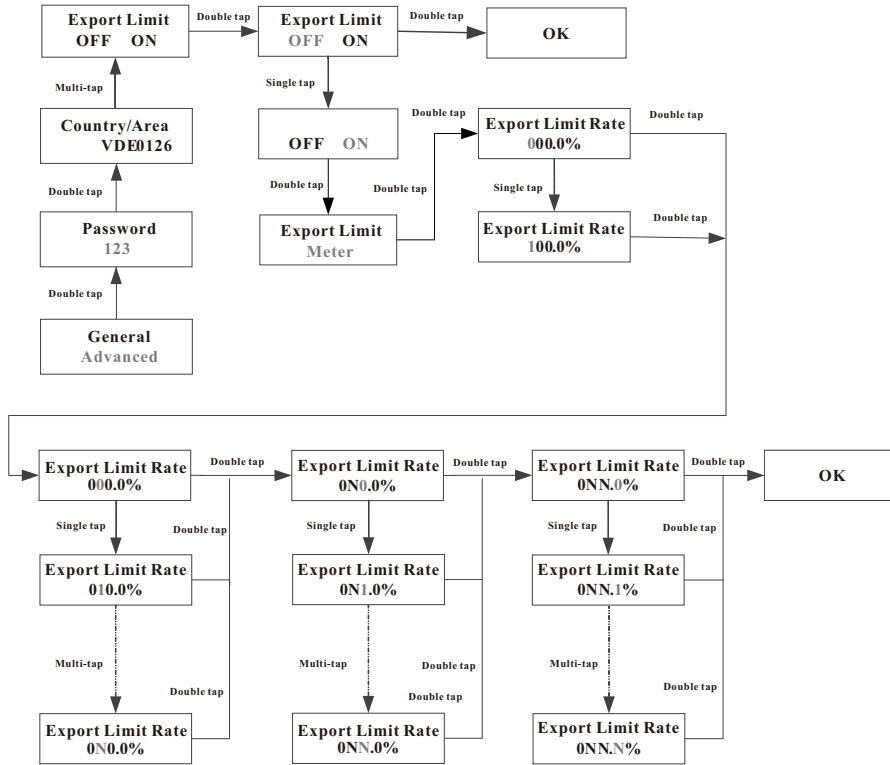

9.3.2 Restoring to factory settings

	Take caution because after this operation, all parameters excluding the current date and time, will restore to the default factory settings.
--	--

Single tap to view the options available or increase the number by one; double tap to confirm your setting.

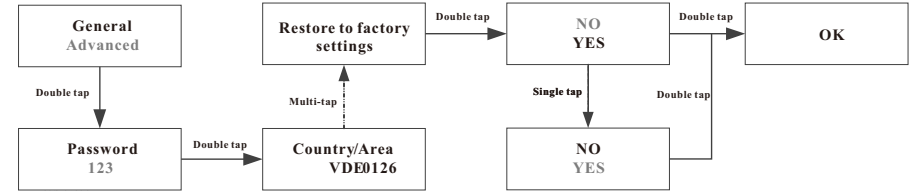

9.3.3 Setting the backup mode (Off-grid models only)

Working with the battery and the backup box, the -XH series inverters can operate in backup mode to supply power to loads when the grid fails. The maximum output power is equal to the inverter's rated power. You can configure the output voltage (set to 230V/400V by default) and the output frequency (set to 50Hz by default) for the backup mode. If the backup mode is disabled (the inverter stops power output when the grid is lost), you can enable the backup mode on the OLED screen. Single tap to view the options or increase the number by one; double tap to confirm your setting. Configure the backup mode as shown below:

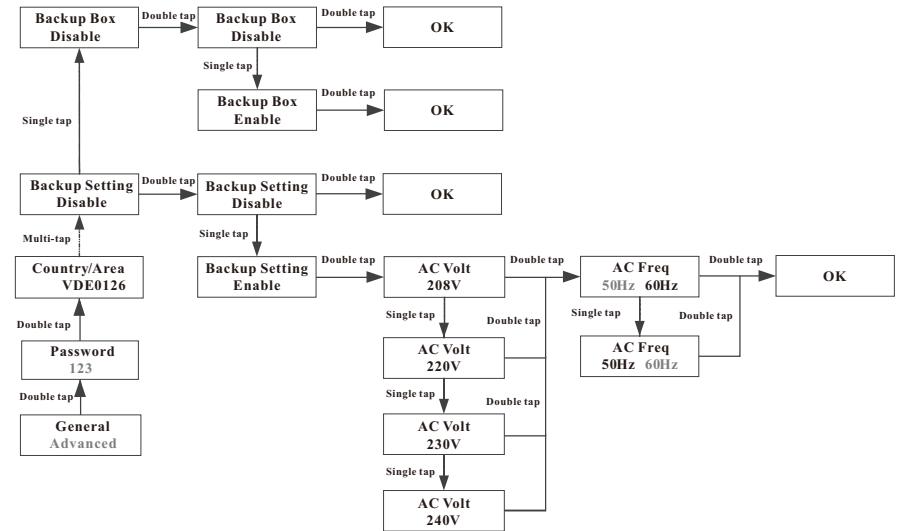

Communication and Monitoring 10

9.3.4 Setting the grid charging function

Working with compatible batteries, the -XH series inverters can draw power from the grid to charge the battery. Users can enable the grid charging function (set to disabled by default) on the OLED screen. Single tap to view the options; double tap to confirm your setting. Configure the grid charging function as shown below:

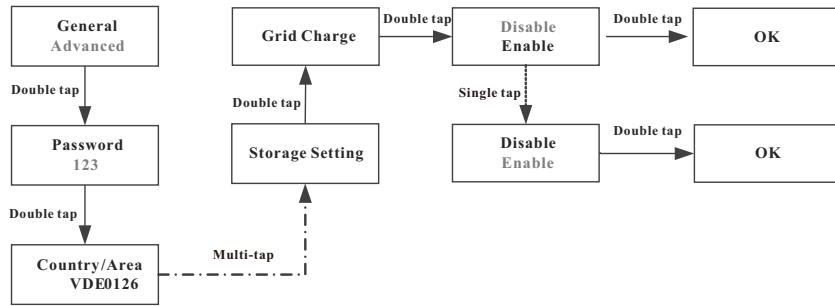

9.3.5 Power derating for voltage variation (Volt-Watt mode)

The inverter regulates the output power based on the AC grid voltage. This feature is enabled by default and is considered an advanced function. If you need to modify this setting, please contact the after-sales O&M team for assistance to make adjustments.

9.3.6 Reactive power regulation for voltage variation (Volt-VAr mode)

The inverter adjusts the input/output power in response to changes in the AC grid voltage. This feature is disabled by default and is considered an advanced function. If you need to modify this setting, please contact the after-sales O&M team for assistance to make adjustments.

10.1 COM port

This series of inverters provide four RS485 ports. You can monitor one or more inverters via RS485. The other RS485 port is used to connect a smart meter (Export limitation and self-consumption monitoring).

No.	Description	Function
1	+12V	Dry contact: the power of any external wiring connected to it should not be greater than 2W
2	COM	
3	RS485A1	RS485 communication port
4	RS485B1	
5	RS485A3	Meter communication port
6	RS485B3	
7	RS485A2	Battery communication port
8	RS485B2	
9	BAT.EN+	Battery wake-up signal
10	BAT.EN-	
11	DRM1/5	Relay contact 1 input
12	DRM2/5	Relay contact 2 input
13	DRM3/7	Relay contact 3 input
14	DRM4/8	Relay contact 4 input
15	REF/GEN	GND
16	DRM0/COM	/
21	BOX.EN+	Backup box identification signal
22	BOX.EN-	
23	RS485A4	Backup box communication
24	RS485B4	
27	RS485A2	Battery communication port 2
28	RS485B2	
29	BAT.EN+	Battery wake-up signal 2
30	BAT.EN-	

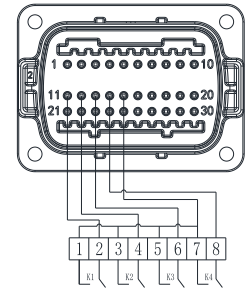

connect to RRCR
Fig 10.1

No.	RRCR Descriptin	Active Power
11	K1-out	0%
12	K2-out	30%
13	K3-out	60%
14	K4-out	100%
15	Relays common node	/
16	/	/

10.2 USB-A

USB-A port is used to connect to the monitoring module and perform firmware update: You can connect the optional monitoring module, such as ShineWiFi-X, Shine4G-X, ShineLan-X to the USB port.

Steps for installing the monitoring module are shown below. Ensure that the triangle icon ▲ is facing upwards, then plug the datalogger and tighten the screw.

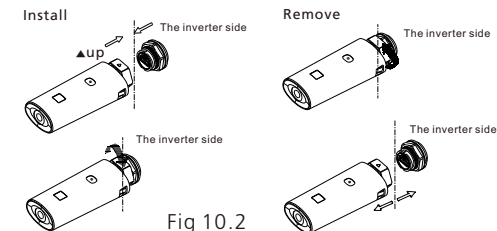

Fig 10.2

11 Maintenance and cleaning

11.1 Checking the heat dissipation

For reduction in power output due to high temperature, you are advised to clean the heat sink to improve heat dissipation.

11.2 Checking the inverter

Before cleaning a dirty inverter, turn off the AC breaker and the DC switch, and wait until the inverter completely shuts down. Clean the enclosure lid, the display and the LED indicators with a cloth moistened with clear water. Do not use any cleaning agents, such as solvents and abrasives, which may cause damage to the equipment and its components.

11.3 Checking the DC disconnect

To ensure safe operation of the system, it is recommended to periodically check the DC disconnect and the cables for any visible damage or discoloration. If any damage or discoloration is found, please contact your installer.

- To extend the service life of the DC disconnect, it is recommended to turn the rotary switch from the ON position to the OFF position 5 times in a row once a year. This will clean the contacts of the switch and ensure optimal performance.

12 Powering on/off the inverter

12.1 Powering on the inverter

Before turning the inverter on, please make sure the PV/Battery input voltage and current are within the MPPT limits.

Follow the steps below to turn the inverter on:

1. Gently pull the cables on the PV/AC/Battery side back to ensure that they are securely connected.
2. Make sure the cable polarity is correct and voltage is less than 1100V.
3. Switch on the built-in DC switch at the bottom of the inverter.
4. Switch on the PV/Battery Array and DC isolator next to your inverter, If the switch is not available. skip this step.
5. Switch on the Solar AC isolator if the inverter is more than 3 meters away from your switchboard.
6. Switch on the solar supply main switch in the switch board.

12.2 Powering off the inverter

 <p>Danger</p>	Don't disconnect the DC connector while the inverter is connected to the grid.
--	--

Steps to turn off the inverter:

1. Disconnect the AC circuit breaker to prevent the inverter from starting again;
2. Turn off the DC switch;
3. Turn off the BAT input switch;
4. Check the operating status of the inverter;
5. Wait until the LED and OLED display are off, indicating that the inverter is completely powered off.

Troubleshooting 13

13.1 Error message

An error message will be displayed on the OLED screen and the LED indicator will turn red when a fault occurs, indicating a system fault or an inverter fault. In some cases, you may need to contact Growatt for technical assistance. To provide you with the necessary support, please have the following information ready:

- Serial number
- Model
- Error message on the OLED screen
- Brief introduction of the problem
- Grid voltage
- DC input voltage
- Can you reproduce the failure?
- Has this problem occurred in the past?
- What were the environmental conditions like when the problem occurred?

Information about photovoltaic panels:

- Manufacturer name and model number of the PV panel
- Output power of the panel
- Voc of the panel
- Vmp of the panel
- Imp of the panel
- The number of panels in each string
- If you need to replace the device, please ship it in the original box.

13.2 System warning

Warning message	Description	Troubleshooting
Warning 200	String fault	1. After shutdown, check if the panel is normal. 2. If the error message persists, please contact Growatt support.
Warning 201	String/PID quick-connect terminals abnormal	1. After shutdown, check the string terminal wiring. 2. If the error message persists, please contact Growatt support.
Warning 202	DC SPD function abnormal	1. After shutdown, check the DC SPD. 2. If the error message persists, please contact Growatt support.
Warning 203	PV Circuit short	1. Check if the PV1 or PV2 wiring is short-circuited. 2. If the error message persists, please contact Growatt support.
Warning 204	Dryconnect function abnormal	1. After shutdown, check the dry Dryconnect wiring. 2. If the error message persists, please contact Growatt support.
Warning 205	PV Boost driver broken	1. Restart the inverter. 2. If the error message persists, please contact Growatt support.
Warning 206	AC SPD function abnormal	1. After shutdown, check the AC SPD. 2. If the error message persists, please contact Growatt support.

Warning message	Description	Troubleshooting
Warning 207	U disk over-current protection	1.Unplug the U disk. 2.Reconnect the U disk after shutdown. 3.If the error message persists, please contact Growatt support.
Warning 208	DC fuse blows	1.After shutdown, check the fuse. 2.If the error message persists, please contact Growatt support.
Warning 209	The DC input voltage exceeds the upper threshold	1.Immediately disconnect the DC switch and check the voltage. 2.If the fault code persists after the voltage restores to the acceptable magnitude, please contact Growatt support.
Warning 210	PV Reversed	1.Check the polarity of the PV input terminals. 2.If the error message persists, please contact Growatt support.
Warning 217	BDC Abnormal	1.Restart the inverter. 2.If the error message persists, please contact Growatt support.
Warning 218	BDC Bus Disconnect	1.Restart the inverter. 2.If the error message persists, please contact Growatt support.
Warning 219	PID function abnormal	1.Restart the inverter. 2.If the error message persists, please contact Growatt support.
Warning 220	Sting Disconnect	1.Check string Connect is normal. 2.If the error message persists, please contact Growatt support.
Warning 221	Sting Current Unbalance	1.Check Pv panel is normal. 2.If the error message persists, please contact Growatt support.
Warning 300	No Utility	1. Check if there is a power outage. 2.If the error message persists, please contact Growatt support.
Warning 301	Grid voltage outrange	1. Check if the grid voltage is within the specified range. 2.If the error message persists, please contact Growatt support.
Warning 302	Grid frequency outrange	1. Check if the grid frequency is within the specified range. 2.If the error message persists, please contact Growatt support.
Warning 303	EPS mode, over load	1.Please reduce the load of EPS output. 2.If the error message persists, please contact Growatt support.

Warning message	Description	Troubleshooting
Warning 304	CT Open or Wrong	1. Check if the AC current sensor is connected properly. 2.If the error message persists, please contact Growatt support.
Warning 305	CT line reversed or Ground fault	1. Check if the L line and N line of the CT are reversely connected. 2.If the error message persists, please contact Growatt support.
Warning 306	CT COM fault	1. Check the connection of the communication cable. 2.If the error message persists, please contact Growatt support.
Warning 307	Communication fault	1. Check the connection of the communication cable. 2.If the error message persists, please contact Growatt support.
Warning 308	Meter Open or Wrong	1. Check if the Meter is connected properly. 2.If the error message persists, please contact Growatt support.
Warning 309	Meter line reversed or Ground fail	1. Check the L line and N line of the Meter is reversed or not. 2.If the error message persists, please contact Growatt support.
Warning 310	NE abnormal	1. Check PE, to ensure that the PE line contact good. 2.If error message still exists, contact Manufacturer.
Warning 311	Sequence Error	No operation is required, the PCS automatically adjusts the phase sequence.
Warning 400	Fan function abnormal	1. After shutdown, check the connection of the fan. 2. Replace the fan. 3. If the error message persists, please contact Growatt support.
Warning 401	Meter abnormal	1. Check if the meter is on. 2. Check if the meter is correctly connected to the inverter.
Warning 402	Communication between the optimizer and the inverter is abnormal	1. Check if the optimizer is on. 2. Check whether the connection between the optimizer and the inverter is normal.
Warning 403	String communication	1. After shutdown, check the string panel wiring. 2. If the error message still exists, contact manufacturer.

Warning message	Description	Troubleshooting
Warning 404	EEPROM abnormal	1. Restart the inverter. 2. If the error message persists, please contact Growatt support.
Warning 405	DSP and COM firmware version mismatch	1. Check the firmware version. 2. If the error message persists, please contact Growatt support.
Warning 406	Boost module error	1. Restart the inverter. 2. If the error message persists, please contact Growatt support.
Warning 407	NTC Temperature too high or NTC is broken	1. Restart the inverter. 2. If the error message persists, please contact Growatt support.
Warning 408	NTC Broken	1. Restart the inverter. 2. If the error message persists, please contact Growatt support.
Warning 409	Reactive power scheduling No response warning	1. Check if shinemaster is open. 2. If the error message persists, please contact Growatt support.
Warning 410	CPU Run abnormal	1. Restart the inverter. 2. If the error message persists, please contact Growatt support.
Warning 411	synchronization signal Abnormal	1. Check the synchronizing signal is abnormal. 2. If the error message persists, please contact Growatt support.
Warning 412	The grid-connected startup condition of the inverter is not met	1. Check whether the grid voltage is out of range or whether the grid-connected voltage setting of the inverter is correct. 2. Check whether the PV voltage is too high or too low. 3. Restart the inverter. 4. If the error message persists, please contact Growatt support.
Warning 500	The Inverter failed to communication with the lithium battery	1. Check if the battery is turned on. 2. Check if the battery is successfully connected to the inverter.
Warning 501	Battery disconnected (Lithium battery only)	1. Check if the battery is connected. 2. If the error message persists, please contact Growatt support.
Warning 502	Battery Voltage high	1. Check if the voltage of the battery is within the specified range. 2. Check the connection of the battery. 3. If the error message persists, please contact Growatt support.

Warning message	Description	Troubleshooting
Warning 503	Battery Voltage Low	1. Check if the voltage of the battery is within the specified range. 2. Check the connection of the battery. 3. If the error message persists, please contact Growatt support.
Warning 504	Battery terminals reversed	1. Check if the positive and negative terminals of the battery are reversely connected. 2. If the error message persists, please contact Growatt support.
Warning 505	Lead-acid battery temperature sensor was disconnected	1. Check if the temperature sensor is installed. 2. Check if the temperature sensor is securely connected. 3. If the error message persists, please contact Growatt support.
Warning 506	Battery temperature outrange	1. Check if the temperature of the battery is within the specified range. 2. If the error message persists, please contact Growatt support.
Warning 507	BMS failure and neither charge and discharge is allowe	1. Figure out the fault based on the BMS error code. 2. If the error message persists, please contact Growatt support.
Warning 508	Lithium battery Over Load Fault	1. Check whether the load power is greater than the battery's rated power. If so, please reduce the load. 2. If the error message persists, please contact Growatt support.
Warning 509	BMS Battery Msg Failure	1. Restart the inverter. 2. If error message still exists, contact manufacture.
Warning 510	BAT SPD function abnormal	1. After shutdown, check the BAT SPD. 2. If the error message persists, please contact Growatt support.
Warning 600	DCI bias abnormal	1. Restart the inverter. 2. If the error message persists, please contact Growatt support.
Warning 601	Output DC component over-high	1. Restart the inverter. 2. If the error message persists, please contact Growatt support.
Warning 602	Off-grid output voltage is too low	1. Restart the inverter 2. If the error message persists, please contact Growatt support.
Warning 603	The off-grid output voltage is too high	1. Restart the inverter. 2. If the error message persists, please contact Growatt support.

Warning message	Description	Troubleshooting
Warning 604	The off-grid output current is overcurrent	1. Check whether the load exceeds the inverter specification. 2. Restart the inverter, If the error message persists, please contact Growatt support.
Warning 605	The off-grid Bus voltage is too low	1. Check whether the load exceeds the inverter specification. 2. Restart the inverter, If the error message persists, please contact Growatt support.
Warning 606	The off-grid output is overloaded	1. Check whether the load exceeds the inverter specification. 2. Restart the inverter, If the error message persists, please contact Growatt support.
Warning 607	Abnormal communication alarm with off-grid box	1. Check and off-grid box communication wiring after shutdown. 2. If the error message persists, please contact Growatt support.
Warning 608	Off-grid box abnormal alarm	1. Restart the inverter. 2. If the error message persists, please contact Growatt support.
Warning 609	Balance Circuit OverLoad	1. Reduce unbalanced loads 2. If the error message persists, please contact Growatt support.
Warning 700	The off-grid box fan is faulty	1. Check the fan wiring after powering it down. 2. If the error message persists, please contact Growatt support.
Warning 701	The generator started abnormally	1. Check the generator and wiring after shutdown. 2. If the error message persists, please contact Growatt support.

13.3 System error

Error code	Description	Troubleshooting
Error 200	AFCI Fault	1. After shutdown, check the panel terminal. 2. Restart the inverter. 3. If the error message persists, please contact Growatt support.
Error 201	Leakage current too high	1. Restart the inverter. 2. If the error message persists, please contact Growatt support.
Error 202	The DC input voltage is exceeding the upper threshold	1. Immediately disconnect the DC switch and check the voltage. 2. If the fault code still exists after the normal voltage is restored, contact Growatt support.
Error 203	PV isolation Low	1. After shutdown, check whether the panel shell is reliably grounded. 2. If the error message persists, please contact Growatt support.
Error 204	PV Reversed	1. After shutdown, check the inverter terminal. 2. Restart the inverter. 3. If the error message persists, please contact Growatt support.
Error 300	AC V Outrange	1. Check grid voltage. 2. If the error message persists when the grid voltage is within the permissible range, please contact Growatt support.
Error 301	AC terminals reversed	1. Check AC terminals. 2. If the error message persists, please contact Growatt support.
Error 302	No AC Connection	1. After shutdown, check the AC wiring. 2. If the error message persists, please contact Growatt support.
Error 303	NE abnormal	1. Check if the PE cable is securely connected. 2. If the error message persists, please contact Growatt support.
Error 304	AC F Outrange	1. Restart the inverter. 2. If the error message persists, please contact Growatt support.
Error 305	Over Load Fault	1. Check whether the output load is out of range; if so, please reduce the load. 2. If the error message persists, please contact Growatt support.
Error 306	CT LN Reversed	1. After shutdown, check the connection of the CT. 2. If the error message persists, please contact Growatt support.
Error 307	CT COM fault	1. Check the connection of the communication cable. 2. If the error message persists, please contact Growatt support.

Error code	Description	Troubleshooting
Error 308	Communication fault;pairing time too long	1.Re-pair the device. 2.If the error message persists, please contact Growatt support.
Error 309	ROCOF Fault	1.Check grid frequency and restart the inverter. 2.If the error message persists, please contact Growatt support.
Error 310	NE Fault	1.confirm whether the N line at the inverter side with PV negative grounding is short circuited with the ground wire, and whether the output side is isolated with a transformer. 2.If error message still exists,contact Manufacturer
Error 311	Backflow fault	1.After shutdown,check the CT or meter connection. 2.If the error message persists, please contact Growatt support.
Error 400	DCI bias abnormal	1.Restart the inverter. 2.If the error message persists, please contact Growatt support.
Error 401	DC voltage high fault	1.Restart the inverter. 2.If the error message persists, please contact Growatt support.
Error 402	Output DC current too high	1.Restart the inverter. 2.If the error message persists, please contact Growatt support.
Error 403	Output current unbalance	1.After shutdown, check if the output current is unbalanced. 2.If the error message still exists, contact manufacturer.
Error 404	Bus sample fault	1.Restart the inverter. 2.If the error message persists, please contact Growatt support.
Error 405	Relay fault	1.Restart the inverter. 2.If the error message persists, please contact Growatt support.
Error 406	Init model fault	1.Reset mode. 2.If the error message persists, please contact Growatt support.
Error 407	Auto-test failure	1.Restart the inverter. 2.If the error message persists, please contact Growatt support.
Error 408	NTC Temperature too high	1.After shutdown, check if the output current is unbalanced. 2.If the error message still exists, contact manufacturer.
Error 409	Bus voltage abnormal	1.Restart the inverter. 2.If the error message persists, please contact Growatt support.

Error code	Description	Troubleshooting
Error 410	Communication board and control panel sampling battery voltage is inconsistent	1.Restart the inverter. 2.If the error message persists, please contact Growatt support.
Error 411	Communication fault	1.After shutdown,check the wiring of the communication board 2. If the error message still exists, contact manufacturer
Error 412	Temperature sensor connection is abnormal	1.After shutdown,check if the temperature sampling module is properly connected. 2.If the error message still exists, contact manufacturer
Error 413	IGBT drive fault	1.Restart the inverter. 2.If the error message persists, please contact Growatt support.
Error 414	EEPROM fault	1.Restart the inverter 2.If the error message persists, please contact Growatt support.
Error 415	Internal power test fail (PV Power low)	1.Restart the inverter. 2.If the error message persists, please contact Growatt support.
Error 416	Over current protected by software	1.Restart the inverter. 2.If the error message persists, please contact Growatt support.
Error 417	System communication protocol does not match	1.Restart the inverter. 2.If the error message persists, please contact Growatt support.
Error 418	DSP and COM firmware version unmatched	1.Check the firmware version. 2.If the error message persists, please contact Growatt support.
Error 419	DSP software version and Hardware version unmatched	1.Check the firmware version. 2.If the error message persists, please contact Growatt support.
Error 420	GFCI Module damage	1.After shutdown,check the leakage current module. 2.If the error message still exists, contact manufacturer.
Error 421	CPLD is abnormal	1.Restart the inverter. 2.If the error message persists, please contact Growatt support.
Error 422	Sampling is inconsistent	1.Restart the inverter. 2.If the error message persists, please contact Growatt support.

Error code	Description	Troubleshooting
Error 423	AC PWM Bypass Protect	1.Restart the inverter. 2.If the error message persists, please contact Growatt support.
Error 424	INV current abnormal	1.Restart the inverter. 2.If the error message persists, please contact Growatt support.
Error 425	AFCI self-test fault	1.Restart the inverter 2.If the error message persists, please contact Growatt support.
Error 426	Communication board and control panel sampling battery voltage is inconsistent	1.Restart the inverter 2.If the error message persists, please contact Growatt support.
Error 427	Communication board and control panel sampling battery voltage is inconsistent	1.Restart the inverter 2.If the error message persists, please contact Growatt support.
Error 428	BOOST Short Out	contact manufacturer.
Error 429	Bus voltage softstart fail	1.Restart the inverter 2.If the error message persists, please contact Growatt support.
Error 431	Monitoring chip BOOT verification failed	contact manufacturer.
Error 432	The system battery model is not compatible	1.Replacing the system battery model. 2.If the error message persists, please contact Growatt support.
Error 433	The system battery software is not compatible	1.Update the system battery software 2.If the error message persists, please contact Growatt support.
Error 500	BMS Communication fault	1.Check the RS485 cable between the inverter and the battery. 2.Check if battery is sleeping. 3.If the error message persists, please contact Growatt support.
Error 501	BMS failure and neither charge nor discharge is allowed	1.Determine the cause based on the BMS error code. 2.If the error message persists, please contact Growatt support.
Error 502	Battery voltage low	1.Check the battery voltage 2.If the error message persists, please contact Growatt support.

Error code	Description	Troubleshooting
Error 503	Battery voltage high	1.Check whether the battery voltage exceeds the permissible range; if so, replace the battery; if not, restart the inverter. 2.If the error message persists, please contact Growatt support.
Error 504	Battery temperature out of specified range for charge or discharge	1.Check battery temperature. 2.If the error message persists, please contact Growatt support.
Error 505	Battery terminals reversed	1.Check the connection of the battery terminals. 2.If the error message persists, please contact Growatt support.
Error 506	Battery terminal open (only for lithium battery)	1.Check the battery terminals. 2.If the error message persists, please contact Growatt support.
Error 507	Lithium battery Over Load Fault	1.Check whether the output load is greater than the battery's rated power; if so, please reduce the load. 2.If the error message persists, please contact Growatt support.
Error 508	BUS2 Volt Abnormal	1.Restart the inverter. 2.If the error message persists, please contact Growatt support.
Error 509	Bat Charge Ocp	1.Check whether the PV voltage is overconfigured. 2.If the error message persists, please contact Growatt support.
Error 510	Bat Discharge Ocp	1.Check whether the battery discharge current is properly set. 2.If the error message persists, please contact Growatt support.
Error 511	Bat Soft Start Fault	1.Restart the inverter. 2.If the error message persists, please contact Growatt support.
Error 600	EPS OP Short Fault	1.Restart the inverter. 2.If the error message persists, please contact Growatt support.
Error 601	Bus low	1.Check whether the battery works properly. 2.If the error message persists, please contact Growatt support.
Error 602	AC port volt Abnormal	1.Check whether the AC port has voltage. 2.If the error message persists, please contact Growatt support.
Error 603	Soft start run out of time	1.Restart the inverter. 2.If the error message persists, please contact Growatt support.
Error 604	Off-grid output voltage is too low	1.Restart the inverter. 2.If the error message persists, please contact Growatt support.

Please refer to the warranty card.

Error code	Description	Troubleshooting
Error 605	Balance Circuit fault	1.Restart the inverter. 2.If the error message persists, please contact Growatt support.
Error 606	DC voltage high fault	1.Restart the inverter. 2.If the error message persists, please contact Growatt support.
Error 607	EPS output over load	1.Restart the inverter. 2.If the error message persists, please contact Growatt support.
Error 608	OfflineSignError	1.Check offline parallel signle. 2.If the error message persists, please contact Growatt support.
Error 609	The off-grid box is not detected	1.After shutdown, check the connection of the backup box. 2.If the error message persists, please contact Growatt support.
Error 610	The off grid split phase voltage is abnormal	1.Powering off the System,check whether the control relay of off-grid box split phase transformer is abnormal. 2. Restart the system,if the error message persists, please contact Growatt support.
Error 700	Abnormal communication with the inverter	1.After shutdown, check the connection of the communication cable. 2.If the error message persists, please contact Growatt support.
Error 701	Off-grid box grid-side relay failure	1.Restart the off-grid box. 2.If the error message persists, please contact Growatt support.
Error 702	Off-grid box generator access relay fault	1.Restart the off-grid box. 2.If the error message persists, please contact Growatt support.
Error 703	Off-grid boxes are overloaded	1.Restart the off-grid box. 2.If the error message persists, please contact Growatt support.
Error 704	Off-grid boxes are overloaded off-grid split-phase	1.Reduce the load. 2.If the error message persists, please contact Growatt support
Error 705	Overheat inside the off-grid box	1.Restart the off-grid box. 2.If the error message persists, please contact Growatt support.

Decommissioning 15

15.1 Removing the inverter

1. Disconnect the inverter as described in Section 8.
2. Remove all connected cables from the inverter.



CAUTION

Danger of burn injuries due to hot enclosure parts!

Wait 20 minutes before removing the inverter until the housing has cooled down.

3. Screw off all projecting cable glands.
4. Lift the inverter off the bracket and unscrew the bracket screws.

15.2 Packing the Inverter

If possible, always pack the inverter in its original carton and secure it with tension belts. If it is no longer available, use packaging that is suitable for the weight and dimensions of the inverter.

15.3 Storing the Inverter

Store the inverter in a dry place where ambient temperatures are always between -25°C and +60°C.

15.4 Disposing of the Inverter



Do not dispose of the product together with the household waste but in accordance with the disposal regulations for electronic waste applicable at the installation site.

16 EU Declaration of conformity

Within the scope of EU directives:

- 2014/35/EU Low Voltage Directive (LVD)
- 2014/30/EU Electromagnetic Compatibility Directive (EMC)
- 2011/65/EU RoHS Directive and its amendment (EU)2015/863

Shenzhen Growatt New Energy Co. Ltd confirms that the Growatt inverters and accessories described in this document are in compliance with the above-mentioned.

EU directives. The entire EU Declaration of Conformity can be found at www.ginverter.com.

Specification 17

Model	MID 11KTL3-XH	MID 12KTL3-XH	MID 13KTL3-XH	MID 15KTL3-XH
Specifications				
Input data (DC)				
Recommended Max. PV power(for module STC)	22000W	24000W	26000W	30000W
Max. DC voltage	1100V			
Start voltage	200V			
Nominal voltage	600V			
MPPT voltage range	160-1000V			
No. of MPP trackers	2			
No. of PV strings per MPP tracker	2/2	2/2	2/2	2/2
Max. input current per MPP tracker	32A/32A	32A/32A	32A/32A	32A/32A
Max. short-circuit current per MPP tracker	40/40A			
Backfeed current to PV array	0A			
DC Battery				
Compatible battery(only)	APX HV Battery (5kWh~60kWh)			
Operating voltage range	600 V ~ 980 V			
Max. operating current	25A/25A			
Max. discharge power	11000W	12000W	13000W	15000W
Max. charge power	15000W/30000W			
Output data (On-gird)				
Nominal AC power	11000W	12000W	13000W	15000W
Max. AC apparent power	12100VA	13200VA	14300VA	16500VA
Nominal AC voltage/range	230/400V			
AC grid frequency/range	50/60 Hz 45~55Hz/55-65 Hz			
Max. output current	18.3A	20A	21.7A	25A
AC inrush current	60A			
Max. output fault current	74.1A			
Max. output overcurrent Protection	74.1A			
Power factor(@nominal power)	>0.99			

Model	MID 11KTL3-XH	MID 12KTL3-XH	MID 13KTL3-XH	MID 15KTL3-XH
THDi	<3%			
AC grid connection type	3W+N+PE			
Efficiency				
Max. efficiency	98.0%			
Euro-eta	97.50%			
Output data (Backup)				
Nominal output power	11000W	12000W	13000W	15000W
Max. apparent power	11000VA	12000VA	13000VA	15000VA
Nominal AC output voltage	230V/400V			
Nominal AC output frequency	50Hz			
Max. output current	16.7A	18.2A	19.7A	22.7A
Power factor	0.8 leading to 0.8 lagging			
THDv	THDv≤2%@Rload, THDv≤5%@RCDload			
DCV	≤300mV AVG			
Switch time	<500ms			
Protection devices				
DC reverse-polarity protection	YES			
DC switch	YES			
DC Surge protection	YES			
Insulation resistance monitoring	YES			
AC surge protection	YES			
AC short-circuit protection	YES			
Grid monitoring	YES			
Anti-islanding protection	YES			
Residual-current monitoring unit	YES			
String Fuse protection	NO			
String monitoring	YES			
AFCI protection	YES			

Model	MID 11KTL3-XH	MID 12KTL3-XH	MID 13KTL3-XH	MID 15KTL3-XH
General data				
Dimensions (W / H / D) in mm	579*433*217.5mm			
Weight	29.5kg			
Operating temperature range	-25°C ... +60°C (>45°C Derating)			
Noise emission (typical)	≤36dB(A)			
Altitude	4000m			
Internal consumption at night	<5.5W			
Topology	Transformerless			
Cooling	Smart air cooling			
IP rating	IP66			
Relative humidity	0~100%			
DC connection	H4/MC4 (OPT)			
AC connection	Waterproof PG head + OT terminal or connect terminal			
Interfaces				
Display	OLED+LED			
USB/RS485	YES			
WIFI/GPRS/4G/RF/LAN	OPT			

Model	MID 17KTL3-XH	MID 20KTL3-XH	MID 25KTL3-XH	MID 30KTL3-XH
Input data (DC)				
Recommended Max. PV power (for module STC)	34000W	40000W	50000W	60000W
Max. DC voltage	1100V			
Start voltage	200V			
Nominal voltage	600V			
MPPT voltage range	160-1000V			
No. of MPP trackers	2		3	
No. of PV strings per MPP tracker	2/2	2/2	2/2/2	2/2/2
Max. input current per MPP tracker	32A/32A	32A/32A	32A/32A/32A	32A/32A/32A
Max. short-circuit current per MPP tracker	40/40A			
Backfeed current to PV array	0A			
DC Battery				
Compatible battery(only)	APX HV Battery (5kWh~60kWh)			
Operating voltage range	600 V ~ 980 V			
Max. operating current	25A/25A			
Max. discharge power	17000W	20000W	25000W	30000W
Max. charge power	15000W/30000KW			
Output data (on-grid)				
Nominal AC power	17000W	20000W	25000W	30000W
Max. AC apparent power	18700VA	22000VA	27500VA	30000VA
Nominal AC voltage/range	230/400V			
AC grid frequency/range	50/60 Hz 45~55Hz/55-65 Hz			
Max. output current	28.3A	33.3A	41.6A	45.5A
AC inrush current	60A			
Max. output fault current	74.1A		106.7A	
Max. output overcurrent Protection	74.1A		106.7A	
Power factor(@nominal power)	>0.99			

Model	MID 17KTL3-XH	MID 20KTL3-XH	MID 25KTL3-XH	MID 30KTL3-XH
Specifications				
THDi	<3%			
AC grid connection type	3W+N+PE			
Efficiency				
Max. efficiency	98.00%			
Euro-eta	97.50%			
Output data (Backup)				
Nominal output power	17000W	20000W	25000W	30000W
Max. apparent power	18700VA	22000VA	27500VA	30000VA
Nominal AC output voltage	230V/400V			
Nominal AC output frequency	50Hz			
Max. output current	25.8A	30.3A	37.9A	45.5A
Power factor	0.8 leading to 0.8 lagging			
THDv	THDv≤2%@Rload, THDv≤5%@RCDload			
DCV	≤300mV AVG			
Switch time	<500ms			
Protection devices				
DC reverse-polarity protection	YES			
DC switch	YES			
DC Surge protection	YES			
Insulation resistance monitoring	YES			
AC surge protection	YES			
AC short-circuit protection	YES			
Grid monitoring	YES			
Anti-islanding protection	YES			
Residual-current monitoring unit	YES			
String Fuse protection	NO			
String monitoring	YES			
AFCI protection	YES			

Certificate of Compliance 18

Growatt confirms herewith that the products, when correctly configured, are in compliance with the requirements specified in the following standards and directives (dated: Apr./2023):

Model	Certificates
MID 11-20KTL3-XH MID 25-30KTL3-XH	CE, IEC 62109, AS 4777.2, En50549, N4105, C10/11, IEC 62116/61727, CEI 0-16, CEI 0-21, UNE217001, UNE217002, NTS TypeA, G99, NC RfG

Model	MID 17KTL3-XH	MID 20KTL3-XH	MID 25KTL3-XH	MID 30KTL3-XH
Specifications				
General data				
Dimensions (W / H / D) in mm	579*433*217.5mm			
Weight	30kg			
Operating temperature range	-25°C ... +60°C (>45°C Derating)			
Noise emission (typical)	≤36dB(A)		≤45dB(A)	
Altitude	4000m			
Internal consumption at night	<5.5W			
Topology	Transformerless			
Cooling	Smart air cooling			
IP rating	IP66			
Relative humidity	0~100%			
DC connection	H4/MC4(OPT)			
AC connection	Waterproof PG head + OT terminal or connect terminal			
Interfaces				
Display	OLED+LED			
USB/RS485	YES			
WIFI/GPRS/4G/RF/LAN	OPT			

Contact us 19

If you have technical problems concerning our products, please contact the Growatt Service Line. To provide you with the necessary support, please have the following information ready:

- Inverter type
- Inverter serial number
- Inverter error message code
- Inverter OLED display content
- Type and number of PV modules connected to the inverter
- Inverter communication method

Shenzhen Growatt New Energy Co., Ltd

4-13/F, Building A, Sino-German (Europe) Industrial Park, Hangcheng Ave, Bao'an District, Shenzhen, China

T +86 0755 2747 1942

E service@ginverter.com

W www.ginverter.com