

# All-in-one solar storage inverter

## User Manual

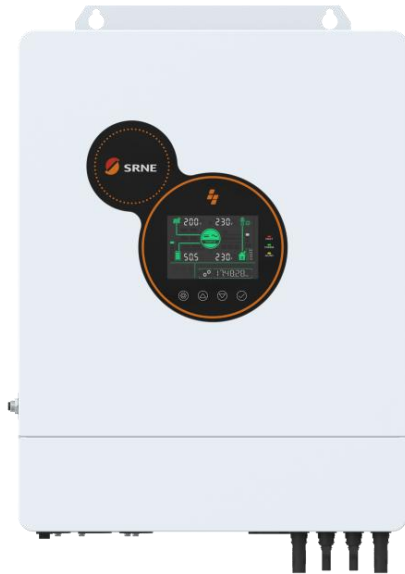

**Product models:**

HYP4860S100-H

## Important safety instructions

### **Please keep this manual for future use.**

This manual contains all safety, installation and operating instructions for the HYP Series all-in-one solar storage inverter.

Please read all instructions and precautions in the manual carefully before installation and use.

- Non-safety voltage exists inside the all-in-one solar storage inverter. To avoid personal injury, users shall not disassemble the all-in-one solar storage inverter themselves. Contact our professional maintenance personnel if there is a need for repair.
- Do not place the all-in-one solar storage inverter within the reach of children.
- Do not install the all-in-one solar storage inverter in harsh environments such as moist, oily, flammable or explosive, or heavily dusty areas.
- The mains input and AC output are high voltage, so please do not touch the wiring terminals.
- The housing of the all-in-one solar storage inverter is hot when it is working. Do not touch it.
- Do not open the terminal protective cover when the all-in-one solar storage inverter is working.
- It is recommended to attach proper fuse or circuit breaker to the outside of the all-in-one solar storage inverter.
- Always disconnect the fuse or circuit breaker near the terminals of PV array, mains and battery before installing and adjusting the wiring of the all-in-one solar storage inverter.
- After installation, check that all wire connections are tight to avoid heat accumulation due to poor connection, which is dangerous.
- The all-in-one solar storage inverter is off-grid. It is necessary to confirm that it is the only input device for load, and it is forbidden to use it in parallel with other input AC power to avoid damage.

# CONTENTS

<b>1. General information .....</b>	<b>1</b>
1.1 Product overview and features .....	1
1.2 Basic system introduction .....	2
1.3 Appearance .....	3
1.4 Dimension drawing .....	5
<b>2.Installation instructions .....</b>	<b>6</b>
2.1Packing list .....	6
2.2 Installation precautions .....	9
2.3Wiring specifications and circuit breaker selection .....	10
2.4 Installation and wiring .....	12
2.5Parallel machine wire connection .....	18
<b>3. LCD screen operating instructions .....</b>	<b>31</b>
3.1 Operation and display panel .....	31
3.2 Setup parameters description .....	35
3.3 Battery type parameters .....	46
<b>4. Other functions .....</b>	<b>48</b>
4.1 Dry contact .....	48
4.2 RS485 communication port .....	48
4.3 can communication port .....	48
4.4 USB communication port .....	49
4.5 WIFI port .....	49
5.5 Parallel communication function .....	49
<b>5.Protection .....</b>	<b>50</b>
5.1 Protections provided .....	50
5.2 Fault code .....	52
5.3 Handling measures for part of faults .....	56

<b>6. Troubleshooting .....</b>	<b>57</b>
<b>7. Technical parameters .....</b>	<b>58</b>

# 1. General information

## 1.1 Product overview and features

HYP series is a new all-in-one solar storage inverter, which integrates solar energy storage & means charging energy storage and AC sine wave output. Thanks to DSP control and advanced control algorithm, it has high response speed, high reliability and high industrial standard. Four charging modes are optional, i.e. Only Solar, Mains Priority, Solar Priority and Mains & Solar hybrid charging; and two output modes are available, i.e. Inverter and Mains, to meet different application requirements. The solar charging module applies the latest optimized MPPT technology to quickly track the maximum power point of the PV array in any environment and obtain the maximum energy of the solar panel in real time.

Through a state of the art control algorithm, the AC-DC charging module realizes fully digital voltage and current double closed loop control, with high control precision in a small volume. Wide AC voltage input range and complete input/output protections are designed for stable and reliable battery charging and protection.

Based on full-digital intelligent design, the DC-AC inverter module employs advanced SPWM technology and outputs pure sine wave to convert DC into AC. It is ideal for AC loads such as household appliances, power tools, industrial equipment, and electronic audio and video equipment. The product comes with a segment LCD design which allows real-time display of the operating data and status of the system. Comprehensive electronic protections keep the entire system safer and more stable.

### Features:

1. Anti-backflow grid connection function, support for inverter and mains power hybrid output, support for use without battery, can be set up for on-grid power generation.
2. Two output modes: mains bypass and inverter output; uninterrupted power supply.
3. Available in 2 charging modes: Only Sola and Mains & Solar hybrid charging.
4. Advanced MPPT technology with an efficiency of 99.9%.
5. Designed with a LCD screen and 3 LED indicators for dynamic display of system data and operating status.
6. With time slot control, you can set the priority of using the mains and battery according to the time slot in conjunction with the local peak and valley tariffs.
7. Power saving mode available to reduce no-load loss.
8. Intelligent variable speed fan efficiently dissipate heat and extend system life.
9. Lithium battery activation by PV solar or mains, allowing access of lead-acid battery and lithium battery.
10. 360 ° all-around protection with a number of protection functions.
11. Complete protections, including short circuit protection, over voltage and under voltage

protection, overload protection, reverse protection, etc.

## 1.2 Basic system introduction

The figure below shows the system application scenario of this product. A complete system consists of the following parts:

**1. PV module:** Convert light energy into DC power, and charge the battery through the all-in-one solar storage inverter, or directly invert into AC power to drive the load.

**2. Mains or generator:** Connected at the AC input, to power the load while charging the battery. If the mains or generator is not connected, the system can also operate normally, and the load is powered by the battery and PV module.

**3. Battery:** Provided to ensure normal power supply to the system loads when solar energy is insufficient and the Mains is not connected.

**4. Household load:** Allow connection of various household and office loads, including refrigerators, lamps, TVs, fans and air conditioners.

**5. All-in-one solar storage inverter:** The energy conversion unit of the whole system.

Specific system wiring method depends on the actual application scenario.

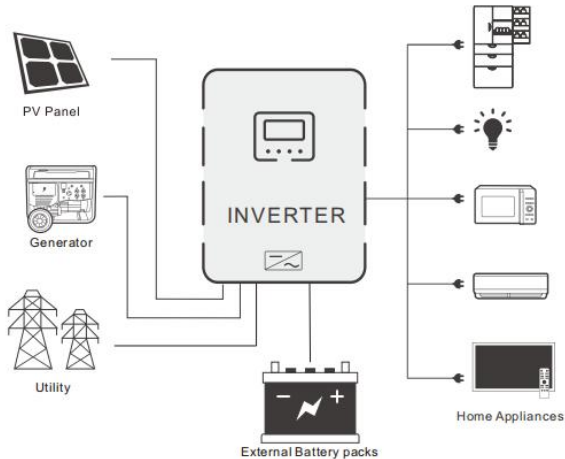

### 1.3 Appearance

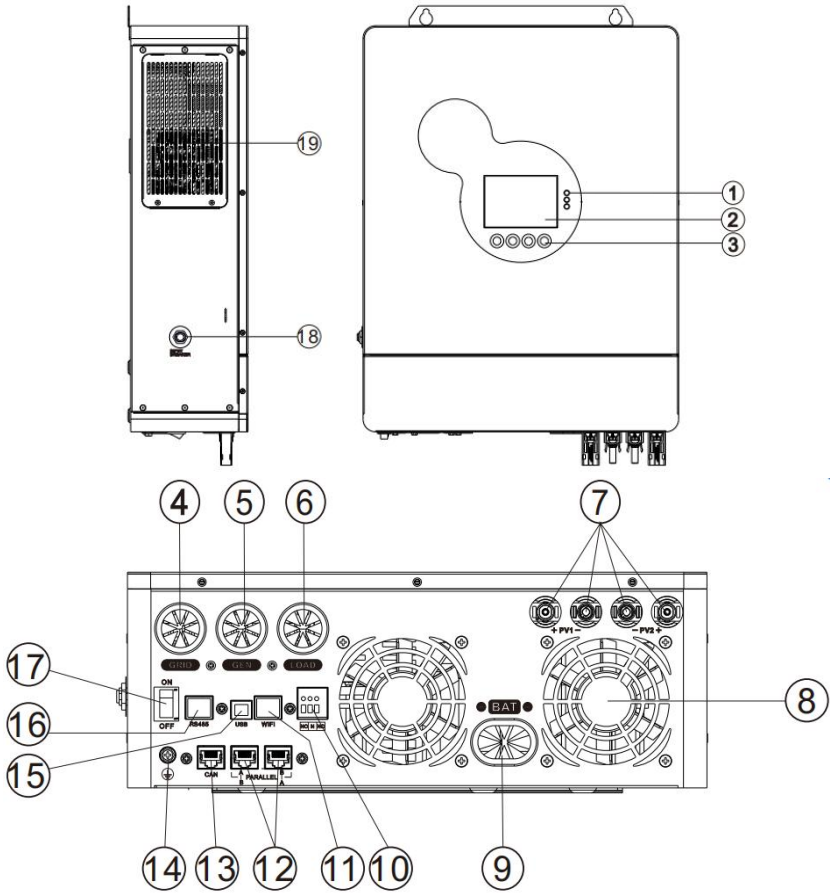

1	Indicator light	10	Dry contact port
2	LCD screen	11	WIFI communication port
3	Touchable key	12	Parallel communication A/Bport
4	Grid input port	13	CAN communication port
5	Generator input port	14	Grounding
6	Load port	15	USB communication port
7	PV1/PV2 port	16	RS485 communication port
8	Cooling fan	17	ON/OFF rocker switch
9	Battery port	18	Overload protector



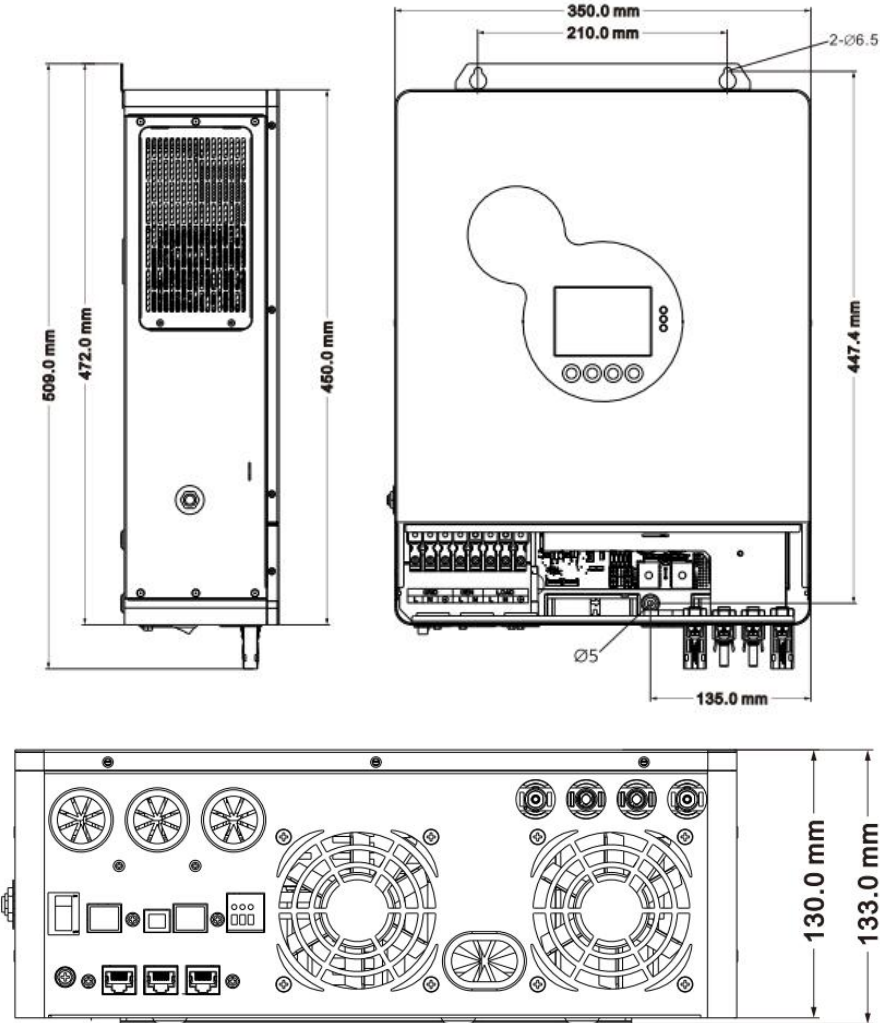

# 1.4 Dimension drawing





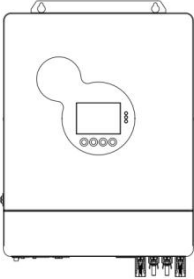
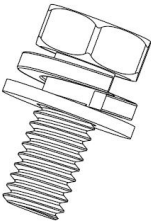
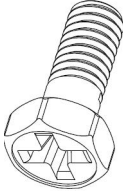

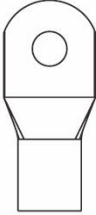
## 2.Installation instructions

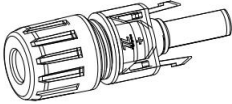
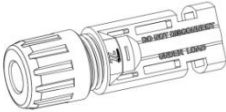
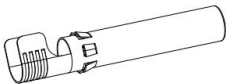
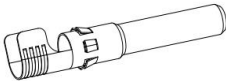
### 2.1Packing list

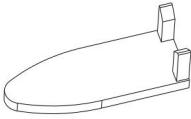
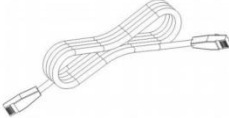
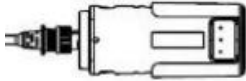
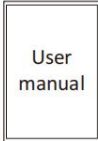
NO.	Pictures	Description	Quantity
1		Inverter	1pcs
2		Phillips screw M6*10mm	2pcs
3		Backup screw M6*10mm	2pcs

4		Copper lug	2pcs
5		Black screw M3X6mm	4pcs
6		PV+ input terminal	2pcs
7		PV- input terminal	2pcs
8		Metal terminals secured to PV+ input power cables	2pcs
9		Metal terminals secured to PV- input power cables	2pcs

10		Remove PV terminal tool	1pcs
11		Parallel communication cable	1pcs
12		WIFI logger	1pcs
13		User manual	1pcs
14		The warranty card	1pcs
15		Quality Certificate	1pcs

16		Outgoing inspection report	1 pcs
----	---	----------------------------	-------

## 2.2 Installation precautions

Please read this manual carefully prior to installation to familiarize yourself with the installation steps.

- Be very careful when installing the battery. Wear safety goggles when installing a lead-acid liquid battery. Once coming into contact with the battery acid, rinse with clean water timely.
- Do not place metal objects near the battery to prevent short-circuit of the battery.
- Acid gas may be generated when the battery is charged. So, please ensure good ventilation.
- When installing the cabinet, be sure to leave enough space around the all-in-one solar storage inverter for heat dissipation. Do not install the all-in-one solar storage inverter and lead-acid battery in the same cabinet to avoid corrosion by acid gas generated during battery operation.
- Only the battery that meets the requirements of the all-in-one unit can be charged.
- Poorly connected connections and corroded wires may cause great heat which will melt the wire insulation, burn the surrounding materials, and even cause fires. So, make sure the connectors have been tightened, and the wires are secured with ties to avoid looseness of connections caused by shaking of wires during mobile application.
- The system connection wires are selected according to a current density of not more than 5 A/mm<sup>2</sup>.
- Avoid direct sunlight and rainwater infiltration for outdoor installation.
- Even after the power is turned off, there is still high voltage inside the unit. Do not open or touch the internal components, and avoid related operations until the capacitor completely discharges.
- Do not install the all-in-one solar storage inverter in harsh environments such as moist, oily, flammable or explosive, or heavily dusty areas.
- Polarity at the battery input end of this product shall not be reversed, otherwise it may damage the device or cause unpredictable danger.

- The mains input and AC output are high voltage, so please do not touch the wiring terminals.
- When the fan is working, do not touch it to prevent injury.
- Load equipment input power needs to confirm that this all-in-one solar storage inverter is the only input device, and it is forbidden to use in parallel with other input AC power to avoid damage. It is necessary to confirm that the solar storage inverter is the only input device for load equipment, and it is forbidden to use it in parallel with other input AC power to avoid damage.

## 2.3 Wiring specifications and circuit breaker selection

Wiring and installation must comply with national and local electrical codes.

Recommended PV array wiring specifications and circuit breaker selection: Since the output current of the PV array is affected by the type, connection method and illumination angle of the PV module, the minimum wire diameter of the PV array is calculated according to its short-circuit current; refer to the short-circuit current value in the PV module specification (the short-circuit current is constant when the PV modules are connected in series; the short-circuit current is the sum of the short-circuit currents of all PV modules connected in parallel); the short-circuit current of the PV array shall not exceed the maximum input current.

- **Refer to the table below for PV input wire diameter and switch:**

Models	Recommended PV wiring diameter	Maximum PV input current	Recommended circuit breaker type
HYP4860S100-H	4mm <sup>2</sup> /12AWG	18A	2P—25A

**Note:** The voltage in series shall not exceed the maximum PV input open circuit voltage.

➤ **Refer to the table below for recommended AC input wire diameter and switch:**

Models	Recommended AC input wiring diameter	Maximum bypass input current	Recommended circuit breaker type
HYP4860S100-H	6mm <sup>2</sup> /10AWG	40A	2P—40A

**Note:** There is already an appropriate circuit breaker at the Mains input wiring terminal, so it is not necessary to add one more.

➤ **Refer to the table below for recommended Generator wire diameter and switch:**

Models	Recommended AC input wiring diameter	Maximum bypass input current	Recommended circuit breaker type
HYP4860S100-H	6mm <sup>2</sup> /10AWG	30A	2P—40A

➤ **Recommended battery input wire diameter and switch selection**

Models	Recommended battery wiring diameter	Rated battery discharge current	Maximum charge current	Recommended circuit breaker type
HYP4860S100-H	35mm <sup>2</sup> /2AWG	130A	100A	2P—160A

➤ **Recommended AC output wiring specifications and circuit breaker selection**

Models	Recommended AC output wiring diameter	Rated inverter AC output current	Maximum bypass output current	Recommended circuit breaker type
HYP4860S100-H	10mm <sup>2</sup> /6AWG	27A	40A	2P—40A

**Note:** The wiring diameter is for reference only. If the distance between the PV array and the all-in-one solar storage inverter or the distance between the all-in-one solar storage inverter and the battery is relatively long, using a thicker wire can reduce the voltage drop to improve system performance.

**Note:** The above are only recommended wiring diameter and circuit breaker. Please select the appropriate wiring diameter and circuit breaker according to actual situations.

## 2.4 Installation and wiring

### Installation steps:

**Step 1:** Determine the installation position and the space for heat dissipation. Determine the installation position of the all-in-one solar storage inverter, such as wall surface; when installing the all-in-one solar storage inverter, ensure that there is enough air flowing through the heat sink, and space of at least 200mm to the left and right air outlets of the inverter shall be left to ensure natural convection heat dissipation. Refer to the installation diagram of the whole machine as above.



**Warning:** Danger of explosion! Never install the all-in-one solar storage inverter and lead-acid battery in the same confined space! Also do not install in a confined place where battery gas may collect.

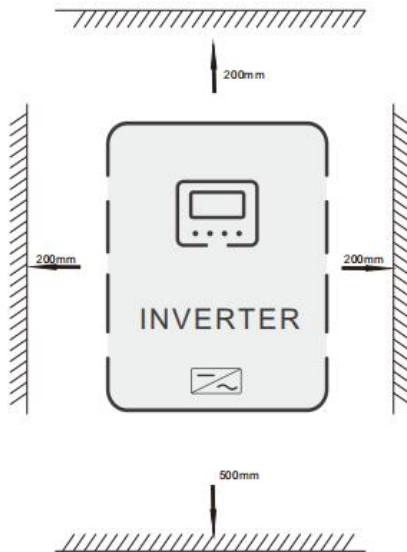



**Step 2:** Remove the terminal cover.

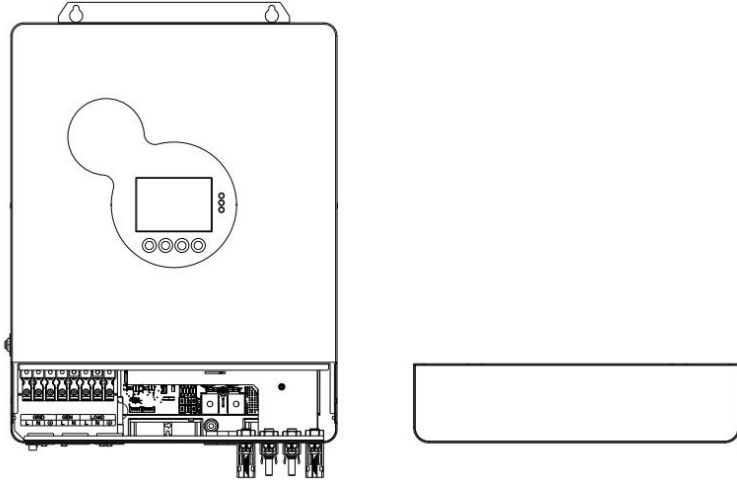

**Step3:** Wiring.

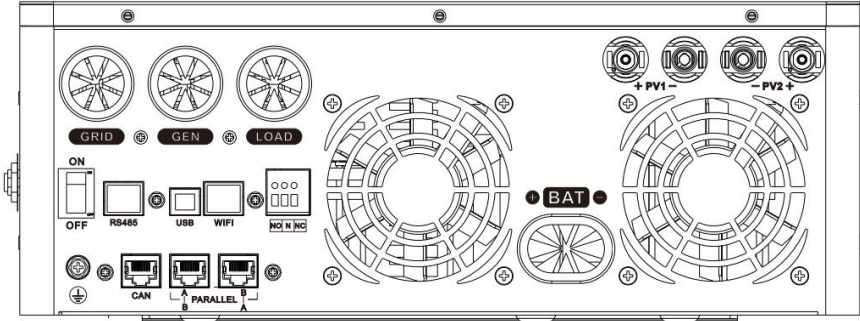

**AC input / output wiring method:**

1. Prior to AC input/output wiring, opening the external circuit breaker and confirm that the wire used is thick enough. Please refer to Section 2.2 "Wiring Specifications and Circuit Breaker Selection" ;
2. Properly connect the AC input wire according to the wire sequence and terminal position shown in the figure below. Please connect the ground wire first, and then the live wire and the neutral wire;

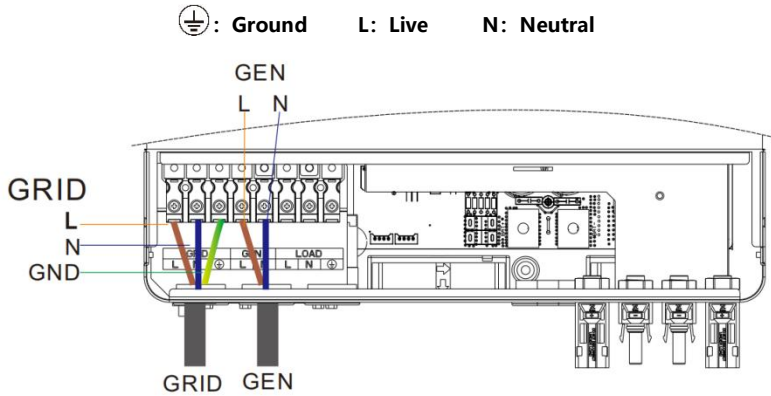

1. Properly connect the AC output wire according to the wire sequence and terminal position shown in the figure below. Please connect the ground wire first, and then the live wire and the neutral wire. The ground wire is connected to the grounding screw hole on the cabinet through the O-type terminal.

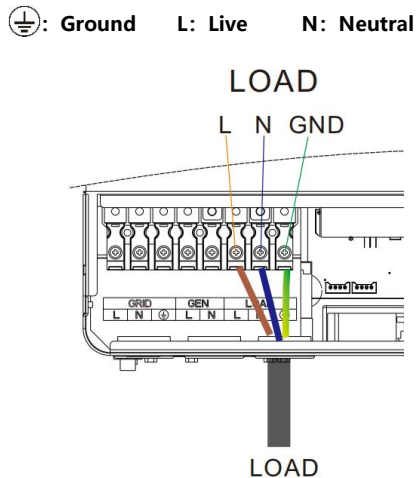

**Note:** The grounding wire shall be as thick as possible (cross-sectional area is not less than  $4\text{mm}^2$ ). The grounding point shall be as close as possible to the all-in-one solar storage inverter. The shorter the grounding wire, the better.

**PV input wiring method:**

1. Prior to wiring, disconnect the external circuit breaker and confirm that the wire used is thick enough. Please refer to Section 2.3 "Wiring Specifications and Circuit Breaker Selection" ;

2. Properly connect the PV input wire according to the wire sequence and terminal position shown in the figure below: When used in parallel connection, different machines need to be connected to different PV arrays or PV sources.

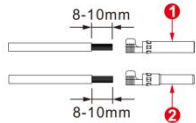
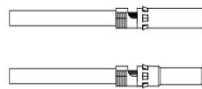
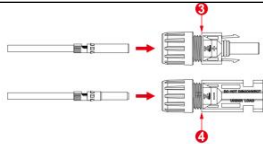
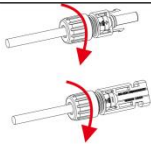
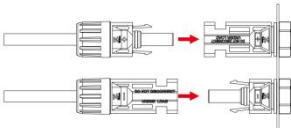
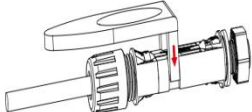
 <p>1.PV+metal contact 2.PV-metal contact</p>	 <p>Press the wire by crimping tool</p>	 <p>3.Positive connector 4.Negative connector Hear "click"</p>
 <p>Tighten terminal</p>	 <p>Connect to the inverter</p>	 <p>Disconnect PV connectors</p>

**BAT wiring method:**

- 1.Prior to wiring, disconnect the external circuit breaker and confirm that the wire used is thick enough. Please refer to Section 2.2 "Wiring Specifications and Circuit Breaker Selection" . The BAT wire needs to be connected to the machine through the O-type terminal. The O-type terminal with an inner diameter of 6mm is recommended. The O-type terminal shall firmly press the BAT wire to prevent excessive heat generation caused by excessive contact resistance;
- 2.Properly connect the BAT wire according to the wire sequence and terminal position shown in the figure below.

**BAT+:** Battery positive electrode

**BAT-:** Battery negative electrode

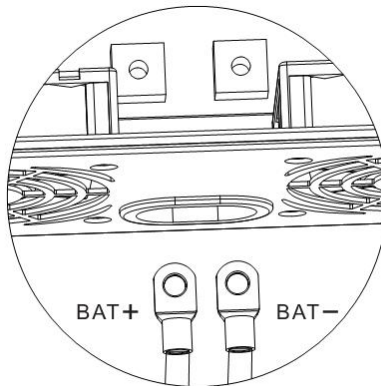

**Warnings:**

- 1.Mains input, AC output and PV array will generate high voltage. So, before wiring, be sure to opening the circuit breaker or fuse;
- 2.Be very careful during wiring; do not close the circuit breaker or fuse during wiring, and ensure that the "+" and "-" pole leads of each component are connected properly; a circuit breaker must be installed at the battery terminal. Refer to Section 2.2 "Wiring Specifications and Circuit Breaker Selection" to select a right circuit breaker. Before wiring, be sure to disconnect the circuit breaker to prevent strong electric sparks and avoid battery short circuit; if the all-in-one solar storage inverter is used in an area with frequent lightning, it is recommended to install an

external lightning arrester at the PV input terminal.

**Step 4:** Check if the wiring is correct and firm. In particular, check if the battery polarity is reversed, if the PV input polarity is reversed and if the AC input is properly connected.

**Step 5:** Install the terminals cover.

**Step 6:** Turn on the all-in-one solar storage inverter.

First, close the circuit breaker at the battery terminal, and then turn the rocker switch on the left side of the machine to the "ON" state. The "AC/INV" indicator flashing indicates that the inverter is working normally. Close the circuit breakers of the PV array and the Mains. Finally, turn on AC loads one by one as the AC output is normal to avoid a protection action caused by a large momentary shock due to simultaneous turning on the loads simultaneously. Now, the machine goes into a normal operation according to the set mode.

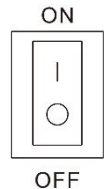

**Note:** If power is supplied to different AC loads, it is recommended to first turn on the load with a large surge current. After the load is stable, turn on the load with a small surge current.

**Note:** If the all-in-one solar storage inverter does not work properly or the LCD or indicator is abnormal, refer to Chapter 6 to handle the exceptions.

## 2.5 Parallel machine wire connection

### 2.5.1 Introduction

1. Up to six units connected in parallel.
2. When using the parallel operation function, the following connecting lines (package accessories) shall be firmly and reliably connected:

**Parallel communication line\*1:**

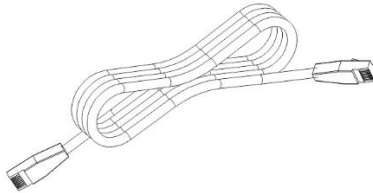

### 2.5.2 Precautions for connecting the parallel connecting lines

Warning: 

#### **PV connection:**

When used in parallel connection, different machines need to be connected to different PV arrays or PV sources.

#### **Battery wiring:**

**Parallel connection in single or split phase:** Ensure that all all-in-one solar storage inverters are connected to the same battery, with BAT + connected to BAT + , BAT - connected to BAT -, and that the connection is correct with the same wiring length and line diameter before power on and start-up, so as to avoid the abnormal operation of parallel system output caused by wrong connection.

## AC OUT wiring:

**Parallel connection in single phase:** Ensure L-to-L, N-to-N and PE-to-PE connection for all all-in-one solar storage inverters, and that the connection is correct with the same wiring length and line diameter before power on and start-up, so as to avoid the abnormal operation of parallel system output caused by wrong connection. For specific wiring, please refer to 2.5.3 Wiring Diagram.

**Parallel connection in three phase:** Ensure N-to-N and PE-to-PE connection for all all-in-one solar storage inverters. The L lines of all inverters connected to the same phase need to be connected together. But L lines of different phases cannot be joined together. Other connection precautions are the same as parallel connection in single phase. For specific wiring, please refer to 2.5.4 Wiring Diagram.

## AC IN wiring:

**Parallel connection in single phase:** Ensure L-to-L, N-to-N and PE-to-PE connection for all all-in-one solar storage inverters, and that the connection is correct with the same wiring length and line diameter before power on and start-up, so as to avoid the abnormal operation of parallel system output caused by wrong connection. Meanwhile, it is not allowed to have multiple different AC source inputs to avoid damage to the external equipment of the inverter. The consistency and uniqueness of AC source input shall be ensured. For specific wiring, please refer to 2.5.3 Wiring Diagram.

**Parallel connection in three phase:** Ensure N-to-N and PE-to-PE connection for all all-in-one solar storage inverters. The L lines of all inverters connected to the same phase need to be connected together. But L lines of different phases cannot be joined together. Other connection precautions are the same as parallel connection in single phase. For specific wiring, please refer to 2.5.4 Wiring Diagram.

### 1. **Wiring of parallel communication line:**

Our parallel communication cable is a shielded 8Pin network connection cable, which can be used for single-phase or three-phase parallel connection. Each machine must be connected with one out and one in. This means that the machine "Parallel\_A" is connected to the

machine to be parallelized "Parallel\_B", and that the machine "Parallel\_A" is not allowed to connect to the "Parallel\_B". "Parallel\_B" or "Parallel\_A" is connected to the machine to be parallelized "Parallel\_A". At the same time, the parallel communication cable of each machine should be fastened with 8Pin network connection cable to avoid disconnection or poor contact of the parallel communication cable, which may cause abnormal operation or damage to the system output.

2. **Wiring of current sharing detection line:**

**Parallel connection in single phase:** Our company's current sharing detection line is a twisted connection line. Ensure the "one-in-one-out" rule when connecting each inverter, that is, connect the current sharing line of the inverter with the current sharing green port of the inverter to be paralleled (choose one port from the two, and there is no mandatory sequence requirement). The current sharing ports of the inverter cannot be connected to each other. In addition, make sure that the red and black current sharing connection lines of each inverter are not manually exchanged, and make sure to tighten the lines with self-contained screws to avoid the abnormal operation or damage of the system output caused by abnormal parallel current sharing detection. For specific wiring, please refer to 2.5.3 Wiring Diagram.

**Parallel connection in split phase:** The current sharing detection lines of all inverters connected to the same phase need to be connected together. But the current sharing detection lines of different phases cannot be joined together. Other connection precautions are the same as parallel connection in single phase. For specific wiring, please refer to 2.5.4 Wiring Diagram.

3. Before or after connecting the system, please carefully refer to the following system wiring diagram to ensure that all wiring is correct and reliable before power on.
4. After the system is wired, powered on and in normal operation, if a new inverter needs to be connected, make sure to disconnect the battery input, PV input, AC input and AC output, and that all all-in-one solar storage inverters are powered off before reconnecting into the system.



## 2.5.3 Schematic diagram of parallel connection in single phase

1. In case of parallel operation with multiple inverters, the schematic diagram of parallel connection is as follows:

a) Two all-in-one solar storage inverters of the system connected in parallel:

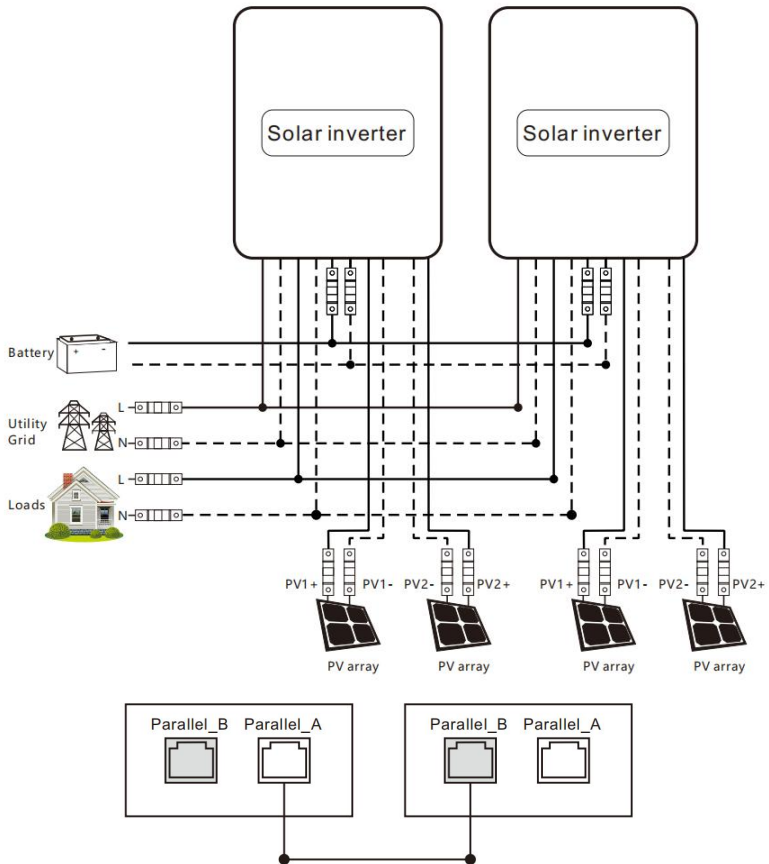

**b) Three all-in-one solar storage inverters of the system connected in parallel:**

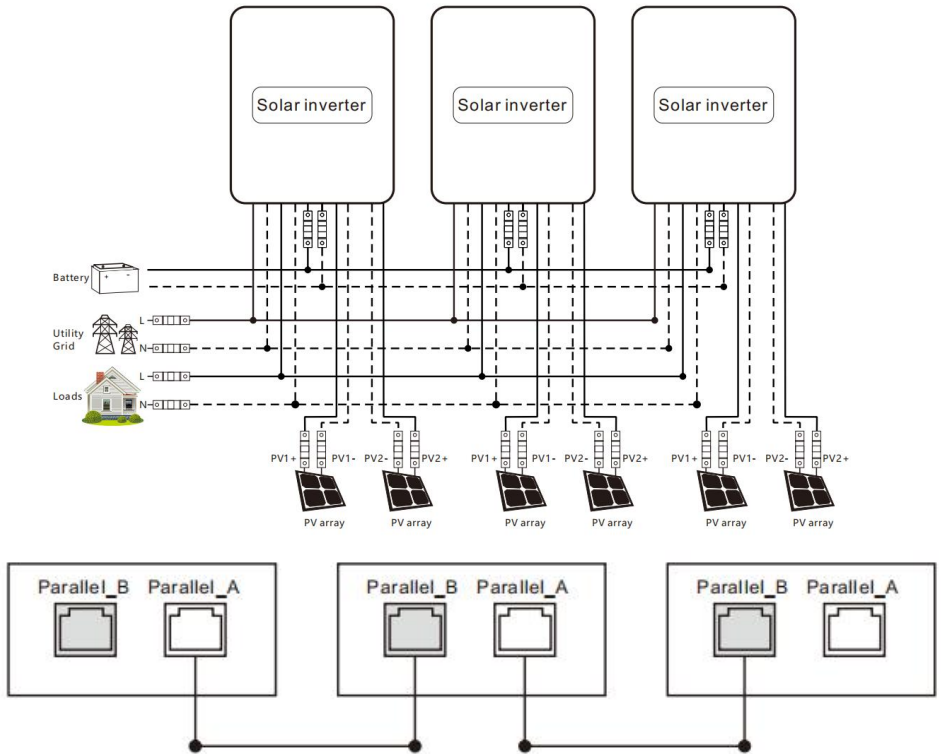

**c) Four all-in-one solar storage inverters of the system connected in parallel:**

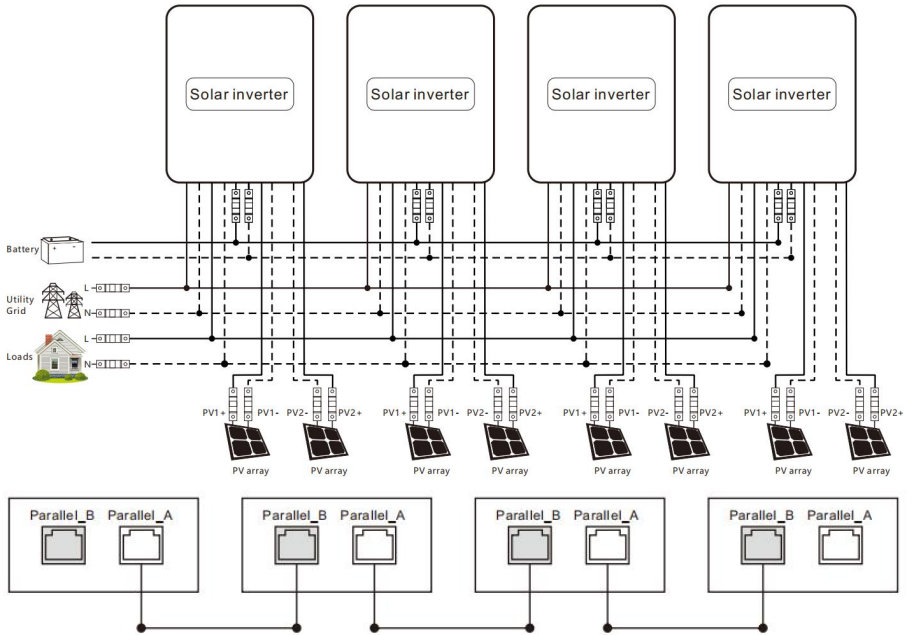

**d) Five all-in-one solar storage inverters of the system connected in parallel:**

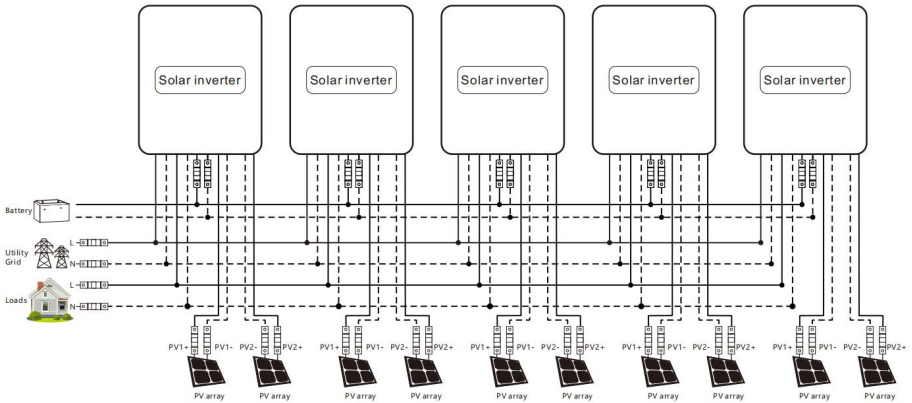

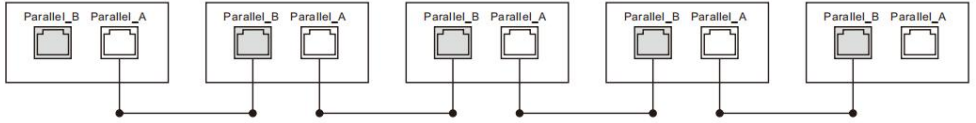

**e) Six all-in-one solar storage inverters of the system connected in parallel:**

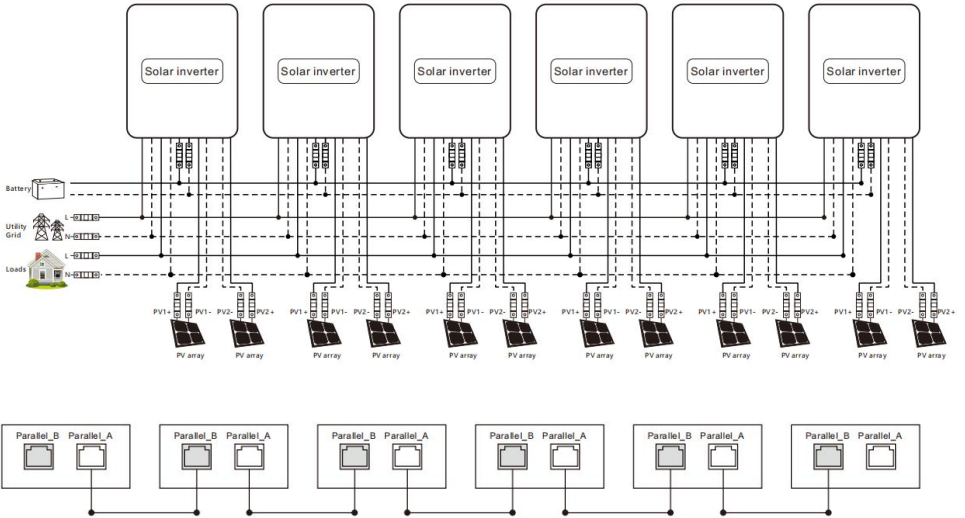

## 2.5.4 Schematic diagram of parallel connection in three phase

1. In case of parallel operation with multiple inverters, the schematic diagram of parallel connection is as follows:

### Parallel Operation in three phase :

a) **Three all-in-one solar storage inverters of the system connected in three phase:**

**1+1+1 system:**

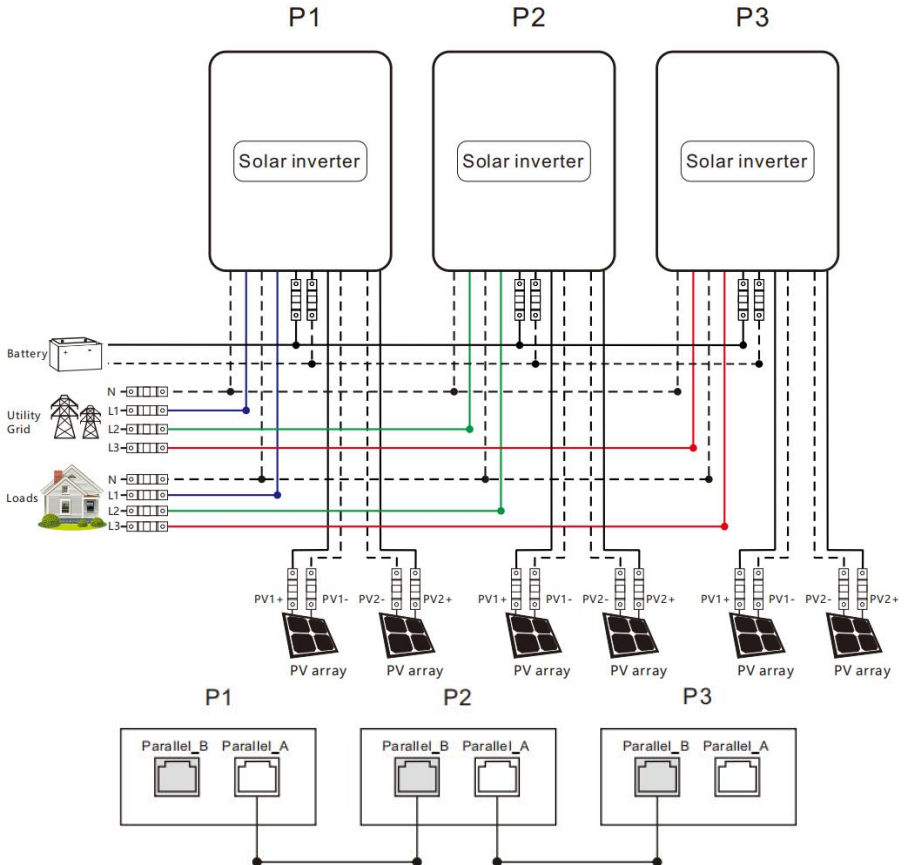

**b) Four all-in-one solar storage inverters of the system connected in three phase:  
2+1+1 system:**

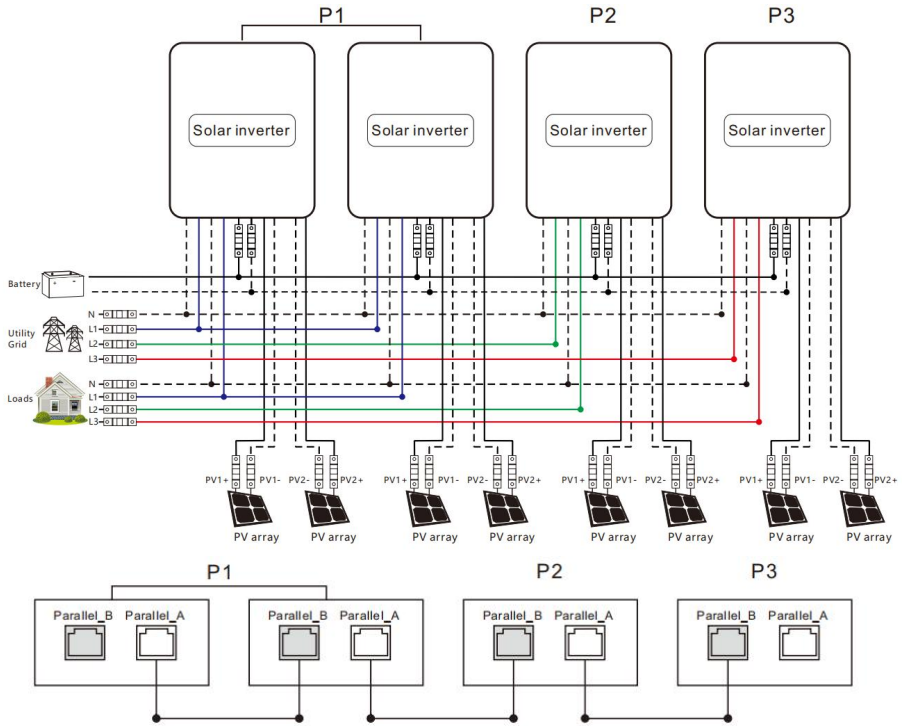

**c) Five all-in-one solar storage inverters of the system connected in three phase:  
3+1+1 system:**

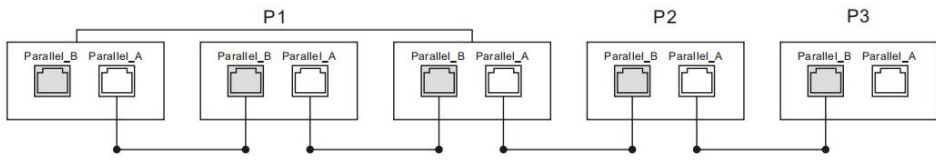
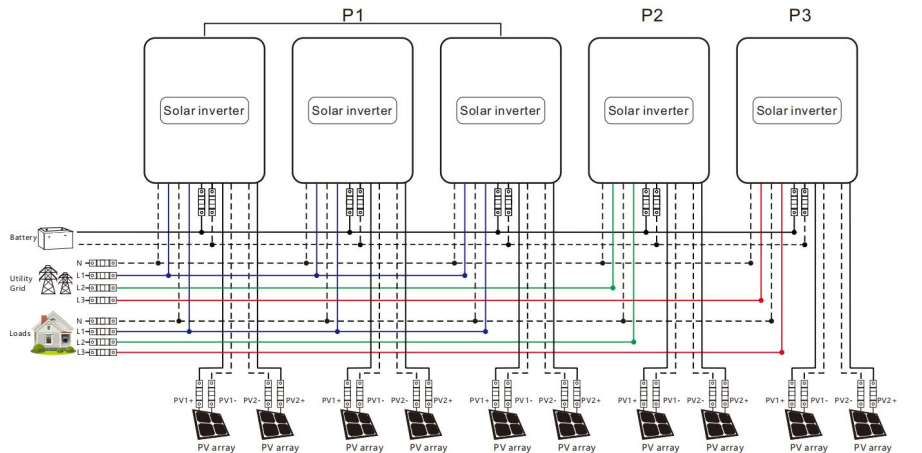

**2+2+1 system:**

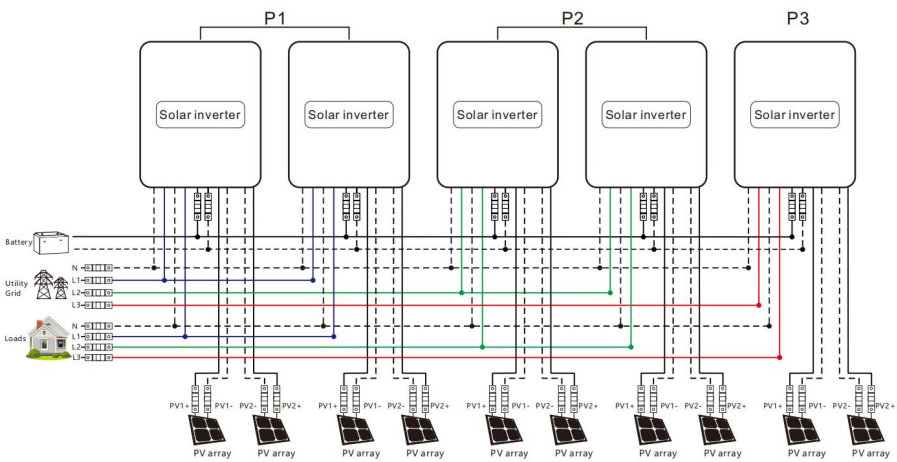

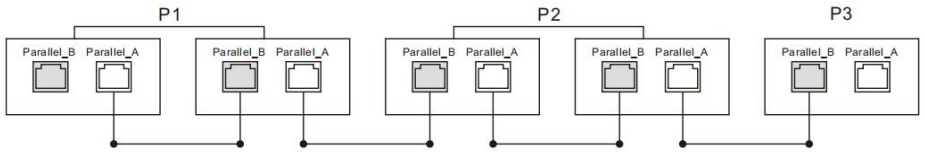

**d) Six all-in-one solar storage inverters of the system connected in three phase:  
2+2+2 system:**

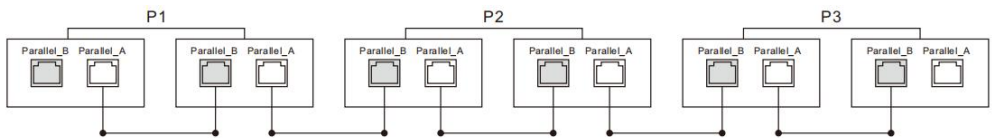
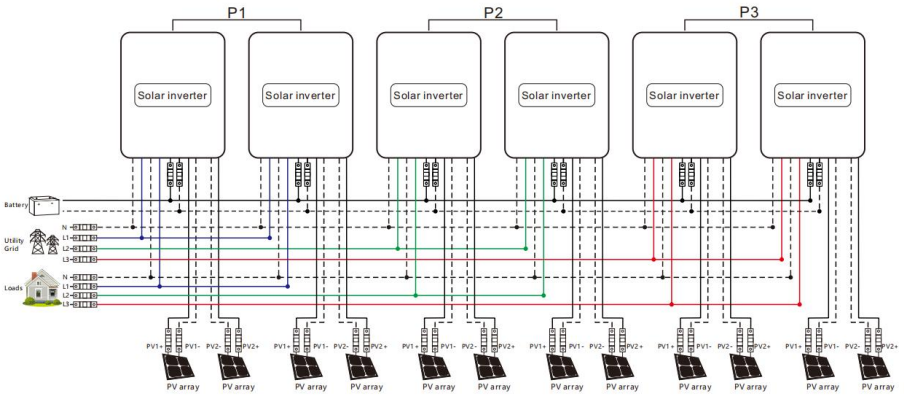

**3+2+1 system:**

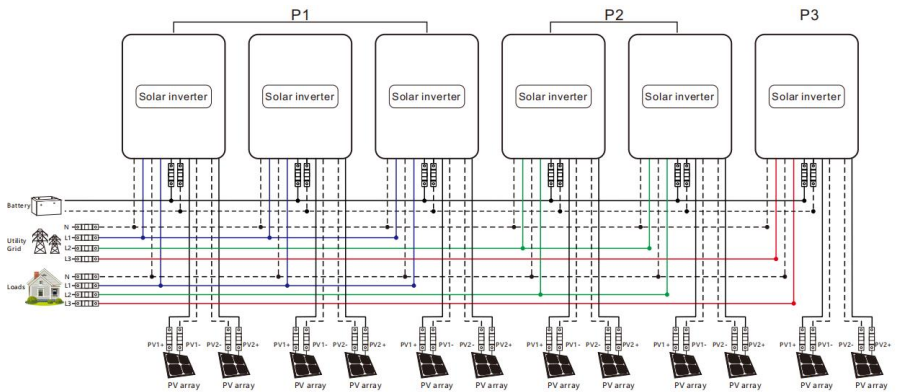



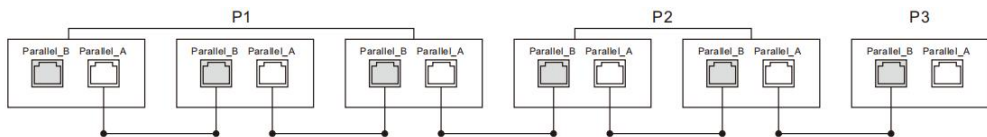

**4+1+1 system:**

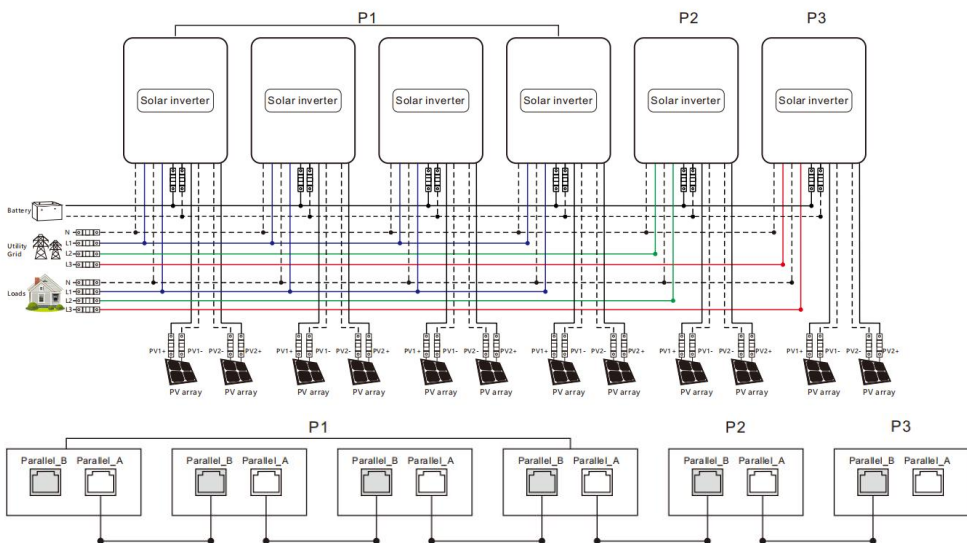

**Note:**

- 1) Before starting up and running, please check whether the connection was correct to avoid any abnormalities in the system.
- 2) All wiring must be fixed and reliable to avoid wire drop during use.
- 3) When the AC output is wired to the load, it shall be properly wired according to the requirements of the electrical load equipment to avoid damage to the load equipment.
- 4) Settings [38] need to be set consistently or only for the host. When the machine is running, the voltage set by the host shall prevail, and the master will force the rewrite of the other slave machines to keep the same set. Only can be set in the standby mode.

- 5) Machine factory default for single machine mode, if you use parallel, split-phase or three-phase function, you need to set the [31] item parameters through the screen. The setting method is: power on one machine at a time, the rest of the machine off, and then set the [31] item parameters according to the site system operation mode. After this machine is set successfully, turn off the machine switch and wait for the machine to be powered down, then set the rest of the machines in turn until all machines are set, and then all machines are powered up again at the same time and enter the working state.

The [31] setting item :

When in single phase parallel connection : setting 【31】 should be set as 【PAL】

When in single phase parallel connection, setting 【31】 should be set as follows:

When in three phase parallel connection ,all machines in phase 1 must be set as “3P1” , all machines in phase 2 must be set as “3P2” all machines in phase 3 must be set as “3P3” , at present, the voltage phase difference between P1-P2, P1-P3 and P2-P3 is 120 degrees.

- a. When the output voltage set in the setting 【38】 is 230Vac (S model), the line voltage between the live wire L1 in phase 1 and the live wire L2 in phase 2 is  $230 \times 1.732 = 398\text{Vac}$ , and similarly the line voltage between L1-L3, L2-L3 is 398Vac; the single phase voltage between L1-N, L2-N, L3-N is 230Vac.
- 6) After the system runs, the output voltage is measured correctly, and then the load setting is connected.

### 3. LCD screen operating instructions

#### 3.1 Operation and display panel

The operation and display panel is shown below, including one LCD screen, 3 indicator lights and 4 operation buttons.

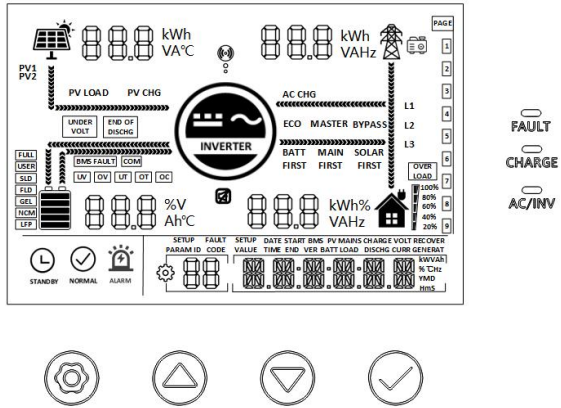

#### Operation buttons introduction

Function Key	Description
	Menu of Enter/Exit Settings
	Page Number/Option Increase
	Page Number/Option Decrease
	Under the menu of Settings, OK/Enter Options

#### Indicators introduction







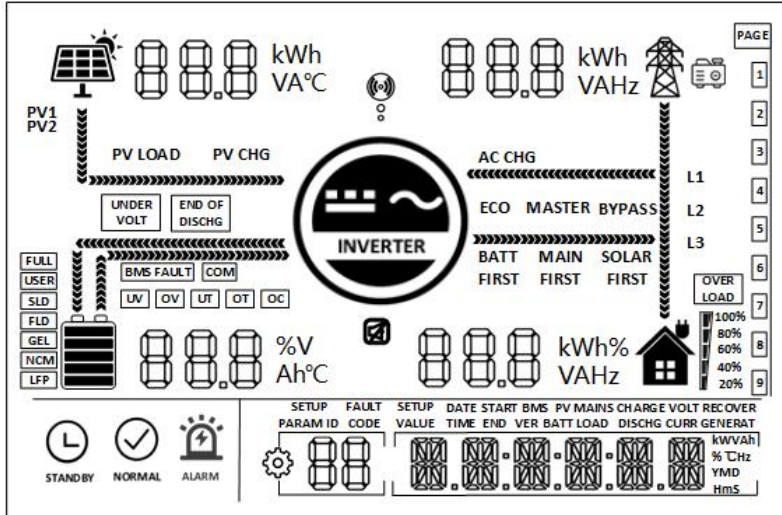



Indicator light	Color	Description
AC/INV	Yellow	Normally On: Mains Power output
		Flicker: Inverter output
CHARGE	Green	Flicker: The battery is being charged.





		Normally OFF: The charging is completed.
FAULT	Red	Normally On: Fault status

LCD screen introduction





Icon	function	Icon	function
	Indicates mains power		Indicates the inverter is working
	Indicates generator		Indicates home appliances
	Indicates solar power		Indicates AC output is overload
	<ul style="list-style-type: none"> <li> Battery remaining capacity is below 5%</li> <li> Battery remaining capacity is 5%~19%</li> <li> Battery remaining capacity is</li> </ul>		<ul style="list-style-type: none"> <li> Load percentage is below 5%</li> <li> Load percentage is 5%~19%</li> <li> Load percentage is 20%~39%</li> </ul>

	<p>20%~39%</p>  Battery remaining capacity is 40%~59%		<p> Load percentage is 40%~59%</p> <p> Load percentage is 60%~79%</p> <p> Load percentage is 80% ~ 100%</p>
	Indicates that the machine is communicating with the Surveillance Equipment		Indicates that the buzzer is not enabled
<b>FULL</b>	Indicates that the battery is fully charged	<b>USER</b>	Indicates that the current battery type of the machine is user-defined
<b>SLD</b>	Indicates that the current battery type of the machine is sealed lead-acid battery	<b>FLD</b>	Indicates that the current battery type of the machine is flooded lead-acid battery
<b>GEL</b>	Indicates that the current battery type of the machine is gel battery	<b>NCM</b>	Indicates that the current battery type of the machine is NCM battery
<b>LFP</b>	Indicates that the current battery type of the machine is LFP battery	<b>PAGE</b>	Display the page number prompt of the main interface
<b>1</b> <b>2</b> <b>3</b> <b>4</b> <b>5</b> <b>6</b> <b>7</b> <b>8</b> <b>9</b>			Indicates the data page of the main display interface
 STANDBY	Indicates that the machine is currently idle	 NORMAL	Indicates that the machine is currently in normal operation
 ALARM	Indicates that the machine is currently in an alarm or fault state		Indicates that the machine is currently in the parameter setting state

<b>PV LOAD</b>	Indicates that the PV is in a direct load state	<b>PV CHG</b>	Indicates that the PV is in a state of charge
<b>AC CHG</b>	Indicates that the AC is in a state of charge	<b>BYPASS</b>	Indicate that the Mains Power is in the bypass state
<b>ECO</b>	Indicates that the system is enabled in the ECO mode	<b>BATT FIRST</b>	Indicates that the output mode is Battery First
<b>MAIN FIRST</b>	Indicates that the output mode is Mains Power first	<b>SOLAR FIRST</b>	The indicated output mode is Solar First.
<b>UNDER VOLT</b>	Indicates battery under voltage	<b>END OF DISCHG</b>	Battery over-discharge
<b>COM</b>	Indicates internal communication failure	<b>UV</b>	Indicates system under voltage
<b>OV</b>	Indicates system over voltage	<b>UT</b>	Indicates system low temperature
<b>OT</b>	Indicates system over temperature	<b>OC</b>	Indicates system over current
<b>BMS FAULT</b>	Indicates BMS communication failure		Indicates the direction of energy flow
	When the system is in alarm or fault state, the main interface displays fault code; display setting options when setting		Display parameters of PV, battery, mains power and load
SETUP DATE START BMS PV MAINS CHARGE VOLT RECOVER VALUE TIME END VER BATT LOAD DISCHG CURR GENERAT 		Main Interface: display real-time time, date, total PV power generation, total load power consumption, RS485 address, version number Setting Interface: display setting contents	









**Real-time data viewing method**

On the LCD main screen, press   the button for page turning to view the real-time data of

the machine.

Page	PV side parameters	Battery side parameters	Mains side parameters	Load side parameters	Comprehensive parameters
1	PV Voltage	Battery Voltage	AC Voltage	Load Voltage	Current Time
2	PV Current	Battery Current	AC Current	Load Current	Current Date
3	PV Power	Battery power	AC Power	Load Power	PV Total kWh
4	PV Today kWh	BMS Batt SOC	On grid power	Load Today kWh	Load Total kWh
5	PV Temperature	BMS Batt Volt	AC Frequency	Load Frequency	RS485 Address
6	Maintenance Parm	INV Temperature	Today on grid enery	Load kVA	Soft Version
7	PV Rated Voltage	Battery Rated Current	Reserved	Load Rated Power	Parallel Mode

### 3.2 Setup parameters description

Key Operation Instructions: Enter the setting menu and exit the setting menu, please press  , After entering the setting menu, the parameter number [00] will flash. At this time, you can press the  and  key to select the parameter code to be set. Then press  to  enter the parameter editing state, at this time, the value of the parameter flashes, adjust the value of the parameter through the  and  , and finally press  to complete the editing of the parameter and return to the parameter selection state.

Parameter Number	Parameter Name	Setting options	Description
00	Exit	[00]ESC	Menu of Exit Settings
01	Supply Priority Mode	[01] AC1ST	PV load priority, when PV energy is insufficient, grid and PV mixed load, only when the grid power is off, the battery starts to discharge
		[01] BT1ST	Inverter First Mode: switch to Mains Power only when the battery is under-voltage or lower than Parameter [04] Set Value.
		[01] PV1ST	Solar First Mode: switch to Mains Power when PV has failed or battery is lower than Parameter [04] Set Value.
		[01] Mix load Default	PV charging priority, and when PV energy is insufficient, the grid and PV will mix load and charge
02	Output Frequency	[02] 50.0 Default	Bypass self-adaptation; when the mains is connected, it automatically adapts to the mains frequency; when the mains is disconnected, the output frequency can be set through this menu. The default output frequency of the 230V machine is 50HZ, and the 120V machine is 60HZ.
		[02] 60.0	
04	Battery to Mains	[04] 46V Default	When the Parameter [01] = BT1ST/PV1ST, the battery voltage is lower than the set value, and the output is switched from inverter to Mains Power, and the set range is 40V~52V.
05	Mains to Battery	[05] 57.6V Default	When the Parameter [01] = BT1ST/PV1ST, the battery voltage is higher than the set value or the battery is fully charged, and the output is switched from mains to inverter, and the set



			range is 48V~60V.
<b>06</b>	Charging mode	[06] Hybrid Default	Hybrid charging by PV and under utility grid give priority to PV, and use utility grid for supplementary if PV energy is insufficient. When the PV energy is sufficient, the utility grid will stop charging. Note: PV and utility grid are available for charging at the same time only when the bypass output is loaded, and only PV charging can be activated when the inverter is working.
		[06] ONLYPV	Only PV charging, no mains charging is enabled.
<b>07</b>	Maximum Charging Current	[07] 80A Default	Set Range of 0~100A
<b>08</b>	Battery type	[08] USER	User-defined, all battery parameters can be set.
		[08] SLd	Sealed lead-acid battery with constant charge voltage of 57.6V and floating charge voltage of 55.2V
		[08] FLd	Flooded lead-acid battery with constant charge voltage of 58.4V and floating charge voltage of 55.2V
		[08] GEL Default	GEL lead-acid battery with constant charge voltage of 56.8V and floating charge voltage of 55.2V
		[08 ]LFP14/LFP15/ <b>LFP16</b> Default	LFP14/LFP15/LFP16 are corresponding to Battery Series of 14, 15 and 16, and their default constant charge voltages are 49.6V, 53.2V and 56.8V respectively, which can be adjusted.
		[08] NCM13/NCM14	NCM lithium battery, adjustable

		[08] No battery	Disconnect battery
<b>09</b>	Boost Voltage	[09] 56.8V Default	Setting of Boost Voltage: Set Range of 48V~58.4V, Step 0.4V, available when the battery type is user-defined and lithium battery.
<b>10</b>	Maximum Boost Duration	[10] 120 Default	Setting of Maximum Boost Duration, which is the maximum charging time when the voltage reaches the Parameter [09] when charging at constant voltage, with the Set Range of 5min~900min, and Step of 5min.
<b>11</b>	Float charge voltage	[11] 56.8V Default	Floating Charge Voltage, with the Set Range of 48V~58.4 V, Step of 0.4 V.
<b>12</b>	Over-discharge voltage	[12] 48.8V Default	Over-discharge Voltage: the battery voltage is lower than such criterion, and the Inverter output is turned off after the time delay parameter is set to [13], with the Set Range of 40V~52V and Step of 0.4V.
<b>13</b>	Over discharge Delay Time	[13] 30S Default	Over-discharge Delay Time: when the battery voltage is lower than the Parameter [12], the inverter output is turned off upon delay of time set by this Parameter, with the Set Range of 5S~50S, Step of 5S.
<b>14</b>	Battery under voltage alarm point	[14] 49.6V Default	Battery under-voltage alarm point: when the battery voltage is lower than such criterion, under-voltage alarm will be given, the output will not be shut down, with the Set Range of 40V~52.8V, Step of 0.4V.
<b>15</b>	Battery Discharge Limit Voltage	[15] 46.4V Default	Battery Discharge Limit Voltage: the battery voltage is lower than such criterion, output and shut down immediately. Set Range of 40V~52V,

			Step of 0.4V, available when the battery type is user-defined and lithium battery.
16	Equalization charge	[16] DIS Default	No equalization charging
		[16] ENA	Enable equalization charging, only Flooded lead-acid batteries, sealed lead-acid batteries and user-defined are effective
17	Equalization Voltage	[17] 56.8V Default	Equalization Charging Voltage, with the Set Range of 48V~58.4V, Step of 0.4V, available for Flooded lead-acid battery, sealed lead-acid battery and user-defined
18	Equalization Charging Time	[18] 120 Default	Equalization Charging Time, with the Set Range of min~900min, Step of 5min, available for Flooded lead-acid battery, sealed lead-acid battery and user-defined
19	Equalized Charging Delay	[19] 240 Default	Equalization Charging Delay, with the Set Range of min~900min, Step of 5min, available for Flooded lead-acid battery, sealed lead-acid battery and user-defined
20	Equalization Charge Interval Time	[20] 30 Default	Equalization Charge Interval Time, 0~30d, Step of 1d, available for Flooded lead-acid battery, sealed lead-acid battery and user-defined
21	Equalization Charging Start-Stop	[21] ENA	Start equalization charging immediately
		[21] DIS Default	Stop equalization charging immediately
22	ECO mode	[22] DIS Default	NO ECO mode
		[22] ENA	When the ECO mode is enabled, if the load is below 50W, the inverter output is delayed for 5 minutes and then the output is turned off. When

			the hull switch is pressed to the "OFF" State, and then pressed to the "ON" State, the inverter will resume the output
23	Overload Automatic Restart	[23] DIS	Overload automatic restart is disabled. If overload occurs, the output will be shut down, and the machine will not be restarted.
		[23] ENA Default	Enable overload auto restart. If overload occurs, shut down output, delay the machine for 3 min and then restart the output. After 5 times in total, no startup will be resumed.
24	Auto restart upon over-temperature	[24] DIS	Over-temperature automatic restart is disabled. If over-temperature occurs, the output will be shut down, and the machine will not be restarted for output.
		[24] ENA Default	Enable automatic restart upon over-temperature. If over-temperature occurs, shut down output, and restart output after the temperature has dropped.
25	Buzzer Alarm	[25] DIS	No Alarm
		[25] ENA Default	Enable alarm
26	Mode Change Reminder	[26] DIS	Alarm is disabled when the status of the main input source has change.
		[26] ENA Default	Alarm is disabled when the status of the main input source has change.
27	Inverter Overload to Bypass	[27] DIS	Automatic switch to Mains Power is disabled when the Inverter is overloaded.
		[27] ENA Default	Automatic switch to Mains Power when the inverter is overloaded.

28	Current of charging under grid electricity	[28] 60A Default	AC output 230Vac, with the Set Range of 0~80A
30	RS485 Address Setting	[30] 1 Default	RS485 communication address can be set within the range of 1~254 for stand-alone mode and 1 to 6 for parallel mode.
31	AC output mode (can be set in the standby mode only)	[31] SIG Default	Single machine setting
		[31] PAL	Single-phase parallel connection setting
		[31] 3P1/3P2/3P3	Three-phase parallel connection setting
		<p><b>All machines in phase 1 must be set as [3P1]</b>  <b>All machines in phase 2 must be set as [3P2]</b>  <b>All machines in phase 3 must be set as [3P3]</b></p> <p><b>1.When the output voltage set in the setting [38] is 230Vac (S model)</b>  At present the line voltage between the live wire L1 in phase 1 and the live wire L2 in phase 2 is <math>230 \times 1.732 = 398\text{Vac}</math>, and similarly the line voltage between L1-L3, L2-L3 is 398Vac; the single phase voltage between L1-N, L2-N, L3-N is 230Vac.</p>	
32	Communication function	[32]DIS	Disable BMS communication
		[32] 485Default	485-BMS communication.
		[32] CAN	CAN-BMS communication
33	BMS communication protocol	[33]WOW	When [32] enables BMS communication, the corresponding lithium battery manufacturer brand should be selected for communication PAC=PACE, RDA=Ritar, AOG=ALLGRAND BATTERY, OLT=OLITER, HWD=SUNWODA, DAQ=DAKING, WOW=SRNE, PYL=PYLONTECH, UOL=WEILAN

<b>34</b>	PV grid-connected power generation function	[34] Off grid Default	Disable this Function
		[34] On GRID	When the battery is full, the excess PV power will be feed to grid.
<b>35</b>	Battery Under-voltage Recovery Point	[35] 52V Default	When the battery is under-voltage, the battery voltage should be greater than this set value to restore the inverter AC output of the battery, and the set range is 44.4V~58.8V.
<b>37</b>	Battery Recharge Recovery Point	[37] 53.6V Default	After the battery is fully charged, the inverter will stop charging, and when the battery voltage is lower than this Value, the Inverter will resume charging again. And the set range is 44.4V~55.6V.
<b>38</b>	AC Output Rated Voltage	[38] 230Vac Default	You can set: 200/208/220/240Vac
<b>39</b>	Charge current limiting method (when BMS is enabled)	[38] LC SET	Max. battery charging current not greater than the value of setting <b>【07】</b>
		[38] LC BMS Default	Max. battery charging current not greater than the limit value of BMS
		[38] LC INV	Max. battery charging current not greater than the logic judgements value of the inverter.
<b>40</b>	1-section start charging time	[40] 00:00:00 Default	Set Range: 00: 00-23: 59: 00
<b>41</b>	1-section end charging time	[41] 00:00:00 Default	Set Range: 00: 00-23: 59: 00
<b>42</b>	2-section start charging time	[42] 00:00:00 Default	Set Range: 00: 00-23: 59: 00
<b>43</b>	2-section end charging time	[43] 00:00:00 Default	Set Range: 00: 00-23: 59: 00
<b>44</b>	3-section start	[44] 00:00:00 Default	Set Range: 00: 00-23: 59: 00

	charging time		
<b>45</b>	3-section end charging time	[45] 00:00:00 Default	Set Range: 00: 00-23: 59: 00
<b>46</b>	Sectional charging function	[46] DIS Default	Disable this Function
		[46] ENA	After the sectioned charging function is enabled, the power supply mode will change to BT1ST, and system will enable the mains power charging only in the set charging period or battery over discharge; If the sectioned discharge function is enabled at the same time, the power supply mode of the system will change to AC1ST, which only enable the mains charging in the set charging period, and switch to the battery inverter power supply mode in the set discharge period or when the mains power is off
<b>47</b>	1-section start discharging time	[47] 00:00:00 Default	Set Range: 00: 00-23: 59: 00
<b>48</b>	1-section end discharging time	[48] 00:00:00 Default	Set Range: 00: 00-23: 59: 00
<b>49</b>	2-section start discharging time	[49] 00:00:00 Default	Set Range: 00: 00-23: 59: 00
<b>50</b>	2-section end discharging time	[50] 00:00:00 Default	Set Range: 00: 00-23: 59: 00
<b>51</b>	3-section start discharging time	[51] 00:00:00 Default	Set Range: 00: 00-23: 59: 00
<b>52</b>	3-section end discharging time	[52] 00:00:00 Default	Set Range: 00: 00-23: 59: 00
<b>53</b>	Sectional discharge function	[53] DIS Default	Disable this Function
		[53] ENA	After the sectioned discharge function is

			enabled, the power supply mode will change to AC1ST and the system will switch to battery inverter power supply only during the set discharge period or when the mains power is off
<b>54</b>	Current date setting	[54] 00:00:00 Default	Set Range: 00:01: 01-99:12:31
<b>55</b>	Current time setting	[55] 00:00:00 Default	Set Range: 00:00: 00-23:59: 59
<b>56</b>	Leakage protection function(NG resistance)	[56] DIS Default	Disable leakage protectionFunction
		[56]ENA	Enable leakage protection function
<b>57</b>	Stop charging current	[57] 2A Default	Charging stops when the default charging current is less than this setting
<b>58</b>	Discharge alarm SOC setting	[58] 15% Default	SOC alarm when capacity is less than this set value (valid when BMS communication is normal)
<b>59</b>	Cut-off discharge SOC Settings	[59] 5% default	Stops discharging when the capacity is less than this setting (valid when BMS communication is normal)
<b>60</b>	Cut-off charge SOC Settings	[60]100% Default	Stops charging when capacity is greater than or equal to this setting (valid when BMS communication is normal)
<b>61</b>	Switch to mains SOC Settings	[61] 10% Default	Switch to mains when capacity is less than this setting (valid when BMS communication is normal)
<b>62</b>	Switch to inverter output SOC Settings	[62] 100% Default	Switches to inverter output mode when capacity is greater than or equal to this setting (valid when BMS communication is normal)
<b>63</b>	N-G automatically connect	[63] DIS Default	Disable automatic switching of N-Gconnections
		[63] ENA	Enable automatic switching of N-G connections



<b>64</b>	Password input	00000 Default	When the screen is off, Input the password to set parameters
<b>65</b>	Password setting	00000 Default	Set the password
<b>67</b>	On grid power	3000 Default	Set the on grid power
<b>70</b>	PV Riso check	DIS Default	Disable PV insulation impedance detection
		ENA	Enable PV insulation impedance detection
<b>73</b>	Generator charge current	40A	Setting range 0-60A
<b>74</b>	Generator input power	6000W Default	Setting range 0-6000W
<b>78</b>	Battery hybrid discharge current	100A Default	When the battery and grid hybrid load, set the battery discharging current.

### 3.3 Battery type parameters

#### For Lead-acid Battery :

Battery type Parameters	Sealed lead acid battery (SLD)	Gel lead acid battery (GEL)	Flooded lead acid battery (FLD)	User-defined (USE)	Adjustable
Overvoltage disconnection voltage	60V	60V	60V	60V	
Battery fully charged recovery point	52V	52V	52V	52V	√
Boost charge voltage	57.6V	56.8V	57.6V	40 ~ 60V	√
Undervoltage alarm voltage([01] fault)	44V	44V	44V	40 ~ 60V	√
Undervoltage alarm voltage recovery point([01] fault)	Undervoltage alarm voltage+0.8V				
Low voltage disconnection voltage([04] fault)	42V	42V	42V	40 ~ 60V	√
Low voltage disconnection voltage recovery point ([04] fault)(setup item [35])	52V	52V	52V	52V	√
Discharge limit voltage	-	-	-	40 ~ 60V	√
Over-discharge delay time	5s	5s	5s	1 ~ 30s	√
Boost charge duration	-	-	-	10 ~ 900 minutes	√

## For Lithium Battery :

Battery type Parameters	Ternary (N13)	Ternary (N14)	LFP (L16)	LFP (L15)	LFP (L14)	Adjustable
Overvoltage disconnection voltage	60V	60V	60V	60V	60V	
Battery fully charged recovery point(setup item [37])	50.4V	54.8V	53.6V	50.4V	47.6V	√
Equalizing charge voltage	-	-	-	-	-	√
Boost charge voltage	53.2V	57.6V	56.8V	53.2V	49.2V	√
Floating charge voltage	53.2V	57.6V	56.8V	53.2V	49.2V	√
Undervoltage alarm voltage([01] fault)	43.6V	46.8V	49.6V	46.4V	43.2V	√
Undervoltage alarm voltage recovery point([01] fault)	Undervoltage alarm voltage+0.8V					
Low voltage disconnection voltage([04] fault)	38.8V	42V	48.8V	45.6V	42V	√
Low voltage disconnection voltage recovery point ([04] fault)(setup item [35])	46V	49.6V	52.8V	49.6V	46V	√
Discharge limit voltage	36.4V	39.2V	46.4V	43.6V	40.8V	√
Over-discharge delay time	30s	30s	30s	30s	30s	√
Equalizing charge duration	-	-	-	-	-	
Equalizing charge interval	-	-	-	-	-	
Boost charge duration	120 minutes	120 minutes	120 minutes	120 minutes	120 minutes	√

## 4. Other functions

### 4.1 Dry contact

Working principle: This dry contact can control the ON/OFF of the diesel generator to charge the battery. ① Normally, the terminals are that the NC-N point is closed and the NO-N point is open; ② When the battery voltage reaches the low voltage disconnection point, the relay coil is energized, and the terminals turn to that the NO-N point is closed while NC-N point is open. At this point, NO-N point can drive resistive loads: 125VAC/1A, 230VAC/1A, 30VDC/1A.

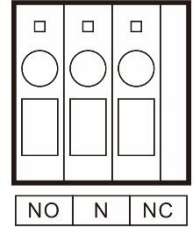

### 4.2 RS485 communication port

**This port is an RS485 communication port which comes with two functions:**  
RS485 communication port for RS485 communication with lithium battery BMS;

**As shown in the figure:**

RS485: Pin1 is RS485-B, and Pin2 is RS485-A, Pin 4 is CANH, and Pin 5 is CANL  
Pin 7 is RS485-A, and Pin 8 is RS485-B;

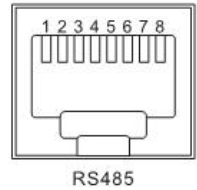

### 4.3 can communication port

CAN communication port for CAN communication with lithium battery BMS;

**As shown in the figure:**

RS485: Pin 4 is CANH, and Pin 5 is CANL;

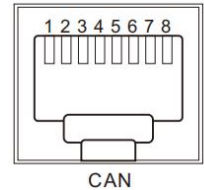

## 4.4 USB communication port

This is a USB communication port, which can be used for USB communication with the optional PC host software. To use this port, you should install the corresponding "USB to serial chip CH340T driver" in the computer.

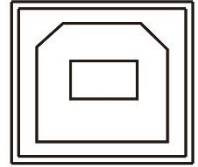

## 4.5 WIFI port

The WIFI port is used to connect to the Wi-Fi/GPRS data acquisition module, which allows the user to view the operating status and parameters of the inverter via the mobile phone APP.

**As shown in the figure:**

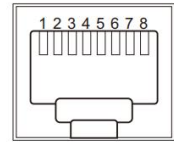

WIFI

RS485: Pin1 is 5v, and Pin2 is GND, Pin 7 is RS485-A, and Pin 8 is RS485-B;

## 5.5 Parallel communication function

- This port is used for parallel communication, through which the parallel modules can communicate with each other.
- Each machine has two 8Pin ports, one for the parallel\_A and one for the parallel\_B.
- When connecting, make sure to connect the local Parallel\_A to the parallelized machine Parallel\_B, or the local Parallel\_B should be connected to the parallelized machine Parallel\_A.
- Do not connect local parallel\_A to local parallel\_B.

Parallel\_A

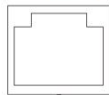

Parallel\_B



## 5. Protection

### 5.1 Protections provided

No.	Protections	Description
1	PV current/power limiting protection	When charging current or power of the PV array configured exceeds the PV rated, it will charge at the rated.
2	PV night reverse-current protection	At night, the battery is prevented from discharging through the PV module because the battery voltage is greater than the voltage of PV module.
3	Mains input over voltage protection	When the mains voltage exceeds 280V (230V model) o, the mains charging will be stopped and switched to the inverter mode.
4	Mains input under voltage protection	When the mains voltage is lower than 170V (230V model /UPS mode) the mains charging will be stopped and switched to the inverter mode.
5	Battery over voltage protection	When the battery voltage reaches the overvoltage disconnection point, the PV and the mains will be automatically stopped to charge the battery to prevent the battery from being overcharged and damaged.
6	Battery low voltage protection	When the battery voltage reaches the low voltage disconnection point, the battery discharging will be automatically stopped to prevent the battery from being over-discharged and damaged.
7	Load output short circuit protection	When a short-circuit fault occurs at the load output terminal, the AC output is immediately turned off.
8	Heat sink over temperature protection	When the internal temperature is too high, the all-in-one machine will stop charging and discharging; when the temperature returns to normal, charging and discharging will resume.
9	Overload protection	Output again 3 minutes after an overload protection, and turn the output off after 5 consecutive times of overload protection until the machine is re-powered. For the specific overload level and duration, refer to the technical parameters table in the manual.

10	PV reverse polarity protection	When the PV polarity is reversed, the machine will not be damaged.
11	AC reverse protection	Prevent battery inverter AC current from being reversely input to Bypass. (In off-grid mode)
12	Bypass over current protection	Built-in AC input overcurrent protection circuit breaker.
13	Battery input over current protection	When the discharge output current of the battery is greater than the maximum value and lasts for 1 minute, the AC input would switched to load.
14	Battery input protection	When the battery is reversely connected or the inverter is short-circuited, the battery input fuse in the inverter will blow out to prevent the battery from being damaged or causing a fire.
15	Charge short protection	When the external battery port is short-circuited in the PV or AC charging state, the inverter will protect and stop the output current.
16	CAN communication loss protection	In parallel operation, an alarm will be given when CAN communication is lost.
17	Parallel connection error protection	In parallel operation, the equipment will be protected when the parallel line is lost.
18	Parallel battery voltage difference protection	In parallel operation, the equipment will be protected when the battery connection is inconsistent and the battery voltage is greatly different from that detected by the host.
19	Parallel AC voltage difference protection	In parallel operation, the equipment will be protected when the AC IN input connection is inconsistent.
20	Parallel current sharing fault protection	In parallel operation, the running equipment will be protected when the load difference of each inverter is large due to improper connection of current sharing line or device damage.
21	Synchronization signal fault protection	The equipment will be protected when there is a fault in the guidance signal between parallel buses, causing inconsistent behavior of each inverter.

## 5.2 Fault code

<b>Fault code</b>	<b>Fault name</b>	<b>Whether it affects the output or not</b>	<b>Description</b>
<b>[01]</b>	BatVoltLow	NO	Battery undervoltage alarm
<b>[02]</b>	BatOverCurrSw	Yes	Battery discharge average current overcurrent software protection
<b>[03]</b>	BatOpen	Yes	Battery not-connected alarm
<b>[04]</b>	BatLowEod	Yes	Battery undervoltage stop discharge alarm
<b>[05]</b>	BatOverCurrHw	Yes	Battery overcurrent hardware protection
<b>[06]</b>	BatOverVolt	Yes	Charging overvoltage protection
<b>[07]</b>	BusOverVoltHw	Yes	Bus overvoltage hardware protection
<b>[08]</b>	BusOverVoltSw	Yes	Bus overvoltage software protection
<b>[09]</b>	PvVoltHigh	NO	PV overvoltage protection
<b>[10]</b>	PvOCSw	NO	Boost overcurrent software protection



<b>【11】</b>	PvOCHw	NO	Boost overcurrent hardware protection
<b>【13】</b>	OverloadBypass	Yes	Bypass overload protection
<b>【14】</b>	OverloadInverter	Yes	Inverter overload protection
<b>【15】</b>	AcOverCurrHw	Yes	Inverter overcurrent hardware protection
<b>【17】</b>	InvShort	Yes	Inverter short circuit protection
<b>【19】</b>	OverTemperMppt	NO	Buck heat sink over temperature protection
<b>【20】</b>	OverTemperInv	Yes	Inverter heat sink over temperature protection
<b>【21】</b>	FanFail	Yes	Fan failure
<b>【22】</b>	EEPROM	Yes	Memory failure
<b>【23】</b>	ModelNumErr	Yes	Model setting error
<b>【26】</b>	RlyShort	Yes	Inverted AC Output Backfills to Bypass AC Input
<b>【29】</b>	BusVoltLow	Yes	Internal battery boost circuit failure

<b>【30】</b>	BatCapacityLow1	NO	Alarm given when battery capacity rate is lower than 10% (setting BMS to enable validity)
<b>【31】</b>	BatCapacityLow2	NO	Alarm given when battery capacity rate is lower than 5% (setting BMS to enable validity)
<b>【32】</b>	BatCapacityLowStop	Yes	Inverter stops when battery capacity is low (setting BMS to enable validity)
<b>【34】</b>	CanCommFault	Yes	CAN communication fault in parallel operation
<b>【35】</b>	ParaAddrErr	Yes	Parallel ID (mailing address) setting error
<b>【37】</b>	ParaShareCurrErr	Yes	Parallel current sharing fault
<b>【38】</b>	ParaBattVoltDiff	Yes	Large battery voltage difference in parallel mode
<b>【39】</b>	ParaAcSrcDiff	Yes	Inconsistent AC input source in parallel mode
<b>【40】</b>	ParaHwSynErr	Yes	Hardware synchronization signal error in parallel mode
<b>【41】</b>	InvDcVoltErr	Yes	Inverter DC voltage error
<b>【42】</b>	SysFwVersionDiff	Yes	Inconsistent system firmware version in parallel mode
<b>【43】</b>	ParaLineContErr	Yes	Parallel line connection error in parallel mode

<b>[44]</b>	Serial number error	Yes	If the serial number is not set by omission in production, please contact the manufacturer to set it
<b>[45]</b>	Error setting of splitphase mode	Yes	[31]Settings item setting error
<b>[58]</b>	BMS communication error	NO	Check whether the communication line is connected correctly and whether [33] is set to the corresponding lithium battery communication protocol
<b>[59]</b>	BMS alarm	NO	Check the BMS fault type and troubleshoot battery problems
<b>[60]</b>	BMS battery low temperature alarm	NO	BMS alarm battery low temperature
<b>[61]</b>	BMS battery over temperature alarm	NO	BMS alarm battery over temperature
<b>[62]</b>	BMS battery over current alarm	NO	BMS alarm battery over current
<b>[63]</b>	BMS battery undervoltage alarm	NO	BMS alarm low battery
<b>[64]</b>	BMS battery over voltage alarm	NO	BMS alarm battery over voltage

### 5.3 Handling measures for part of faults

Fault code	Faults	Remedy
<b>Display</b>	No display on the screen	Check if the battery the PV circuit breaker has been turned off; if the switch is in the "ON" state; press any button on the screen to exit the screen sleep mode.
<b>【06】</b>	Battery overvoltage protection	Measure if the battery voltage exceeds rated, and turn off the PV array circuit breaker and Mains circuit breaker.
<b>【01】</b> <b>【04】</b>	Battery undervoltage protection	Charge the battery until it returns to the low voltage disconnection recovery voltage.
<b>【21】</b>	Fan failure	Check if the fan is not turning or blocked by foreign object.
<b>【19】</b> <b>【20】</b>	Heat sink over temperature protection	When the temperature of the device is cooled below the recovery temperature, normal charge and discharge control is resumed.
<b>【13】</b> <b>【14】</b>	Bypass overload protection, inverter overload protection	① Reduce the use of power equipment; ② Restart the unit to resume load output.
<b>【17】</b>	Inverter short circuit protection	① Check the load connection carefully and clear the short-circuit fault points; ② Re-power up to resume load output.
<b>【09】</b>	PV overvoltage	Use a multimeter to check if the PV input voltage exceeds the maximum allowable input voltage rated.
<b>【03】</b>	Battery disconnected alarm	Check if the battery is not connected or if the battery circuit breaker is not closed.
<b>【40】</b> <b>【43】</b>	Parallel connection fault	Check whether the parallel line is not connected well, such as loose or wrong connection.
<b>【35】</b>	Parallel ID setting error	Check whether the setting of parallel ID number is repeated.
<b>【37】</b>	Parallel current sharing fault	Check whether the parallel current sharing line is not connected well, such as loose or wrong connection.
<b>【39】</b>	Inconsistent AC input source in parallel mode	Check whether the parallel AC inputs are from the same input interface.
<b>【42】</b>	Inconsistent system firmware version in parallel mode	Check whether the software version of each inverter is consistent.

## 6. Troubleshooting

- **In order to maintain the best long-term performance, it is recommended to conduct following checks twice a year.**
  1. Make sure that the airflow around the unit is not blocked and remove any dirt or debris from the heat sink.
  2. Check that all exposed wires are damaged by exposure to sunlight, friction with other objects around them, dryness, bite by insects or rodents, etc., and the wires shall be repaired or replaced if necessary.
  3. Verify for the consistency of indication and display with the operation of the device. Please pay attention to the display of any faults or errors, and take corrective actions if necessary.
  4. Check all wiring terminals for corrosion, insulation damage, signs of high temperature or burning/discoloration, and tighten the screws.
  5. Check for dirt, nesting insects and corrosion, and clean up as required.
  6. If the arrester has failed, replace in time to prevent lightning damage to the unit or even other equipment of the user.

**Warning: Danger of electric shock! When doing the above operations, make sure that all power supplies of the all-in-one machine have been disconnected, and all capacitors have been discharged, and then check or operate accordingly!**

- **The company does not assume any liability for damage caused by:**
  1. Improper use or use in improper site.
  2. Open circuit voltage of the PV module exceeds the maximum allowable voltage rated.
  3. Temperature in the operating environment exceeds the limited operating temperature range.
  4. Disassemble and repair the all-in-one solar storage inverter without permission.
  5. Force majeure: Damage that occurs in transportation or handling of the all-in-one solar charge inverter.

## 7. Technical parameters

Models	HYP4860S100-H
<b>Parallel mode</b>	
Permitted parallel number	1~6
<b>AC mode</b>	
Rated input voltage	220/230Vac
Input voltage range	(170Vac~280Vac) $\pm 2\%$ (90Vac~280Vac) $\pm 2\%$
Frequency	50Hz/ 60Hz (Auto detection)
Frequency Range	47 $\pm$ 0.3Hz ~ 55 $\pm$ 0.3Hz (50Hz); 57 $\pm$ 0.3Hz ~ 65 $\pm$ 0.3Hz (60Hz);
Overload/short circuit protection	Circuit breaker
Max. Efficiency	>95%
Conversion time (bypass and inverter)	10ms (typical)
AC reverse protection	Available
Maximum bypass overload current	40A
<b>Inverter mode</b>	
Output voltage waveform	Pure sine wave
Rated output power (VA)	6200
Rated output power (W)	6200
Power factor	1
Rated output voltage (Vac)	230Vac (200/208/220/240Vac Settable)
Output voltage error	$\pm 5\%$
Output frequency range (Hz)	50Hz $\pm$ 0.3Hz 60Hz $\pm$ 0.3Hz
Maximum Efficiency	>92%
Overload protection	(102% < load <125%): report error and turn off the output after 5 minutes; (125% < load < 150%) : report error and turn off the output after 10 seconds; Load >150% : report error and turn off the output after 5 seconds

Peak power	12400VA
Loaded motor capability	5HP
Rated battery input voltage	48V (Minimum starting voltage 44V)
Battery voltage range	Undervoltage alarm/shutdown voltage/overvoltage alarm /overvoltage recovery... settable on LCD screen)
Power saving mode self-consumption	Load $\leq$ 50W
<b>AC Output (Grid)</b>	
Rated Output Power (W)	6200W
Max. apparent power (VA)	6200VA
Max. output current (A)	27A
THDI	< 3%
Rated voltage(V)	230Vac
Frequency	50Hz/60Hz
<b>AC charging</b>	
Battery type	Lead acid or lithium battery
Maximum charge current(can be set)	0-80A
Charge current error	$\pm$ 3Adc
Charge voltage range	40 –58Vdc
Short circuit protection	Circuit breaker and blown fuse
Circuit breaker specifications	40A
Overcharge protection	Alarm and turn off charging after 1 minute
<b>PV charging</b>	
Maximum PV open circuit voltage	550Vdc
MPPT voltage range	120-480Vdc
Battery voltage range	40-60Vdc
Maximum PV input power	4500W+4500W

Maximum PV input current	18A+18A
PV charging current range (can be set)	0~100A
Charging short circuit protection	Blown fuse
Wiring protection	Reverse polarity protection
<b>Hybrid charging Max charger current specifications (AC charger+PV charger)</b>	
Max charger current(can be set)	100A
<b>Certified specifications</b>	
Certification	EN 62109-1, EN 62109-2, NRS097-2-1
EMC certification level	EN IEC61000-6-3
Operating temperature range	-10°C to 55°C
Storage temperature range	-25°C ~ 60°C
Humidity range	5% to 95% (Conformal coating protection)
Noise	≤60dB
Heat dissipation	Forced air cooling, variable speed of fan
Communication interface	USB / RS485 (WiFi/GPRS) / Dry contact control
Dimension (L*W*D)	510mm*350mm*133mm
Weight (kg)	12.45