

1. Overview

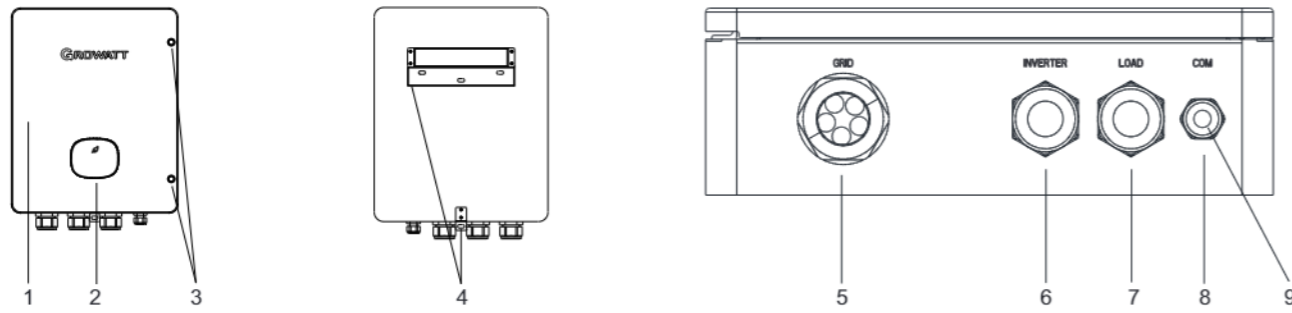

- (1) Front panel (2) LED indicator (3) Screw for front panel (4) Mounting bracket (5) Grid wiring port
- (6) Inverter wiring port (7) Load wiring port (8) COM wiring port (9) Waterproof plugs

2. Installation

System overview

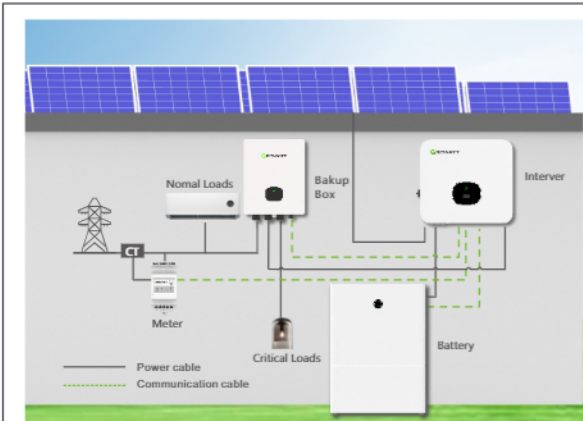

Note:
The critical load power depends on the power rating of the inverter and battery

2.2 Installation requirements

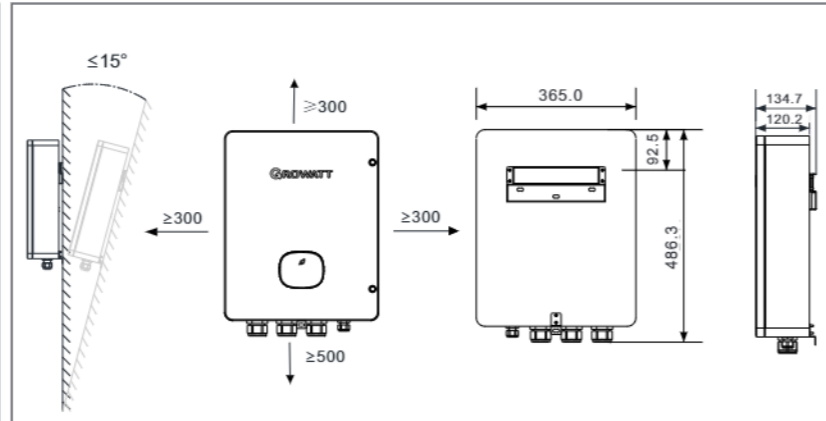

Note: The above dimensions are in "mm".

2.1 Electrical parameters

Model name	SYN 100-XH-30
Nominal grid voltage	3W/N/PE 230/400 a.c.V
Range of grid voltage	312 ~ 485 a.c.V
Max. grid current	125 a.c.A
Max. continuous grid current	90 a.c.A
Nominal grid frequency	50/60Hz
Range of grid frequency	45 ~ 65Hz
Max. continuous inverter input current	58 a.c.A
Max. backup output current	58 a.c.A

2.3 Installation steps

1. Choose a suitable installation position. The SYN 100-XH-30 can be mounted on a solid wall, a stud framing or a pole and keep it free from direct sunlight.
2. To ensure heat dissipation, please maintain at least a 300mm clearance between the SYN 100-XH-30 and other objects.
3. Place the mounting bracket against the wall/pole and mark the drilling hole positions.
4. Drill holes and mount the bracket. Ensure that the bracket is securely installed.
5. Install the SYN 100-XH-30 onto the mounting bracket.

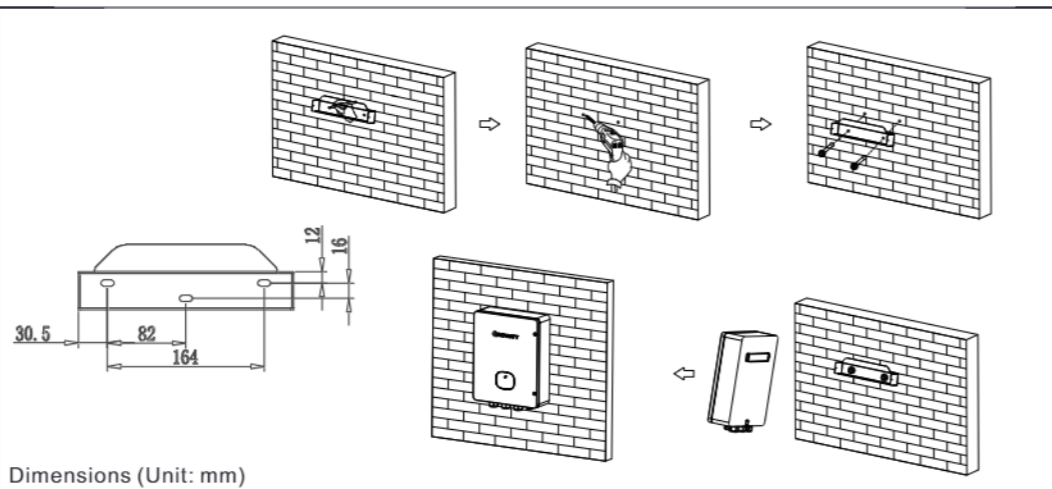

2.4 Required tools

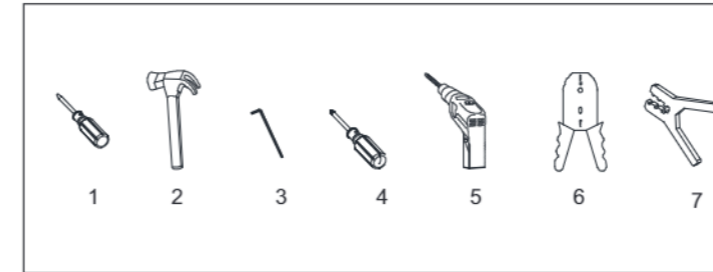

No.	Name	Size	No.	Name	Size
1	Flat-blade screwdriver	Φ2&5mm	2	Hammer	/
3	Allen wrench	Φ5mm	4	Phillips screwdriver	Φ5mm
5	Electric drill	Φ6mm	6	Wire stripper	/
7	Pliers	/			

3. Recommended cable specifications

The cable specifications of this SYN 100-XH-30 are as follows, and the stripped length of the cable is 10mm.

Cable	Cable outer diameter	Cable length
Grid input cable	4-6AWG	10m
Inverter input cable	6-8AWG	20m
Load output cable	6-8AWG	20m
Communication cable	22-26AWG	20m

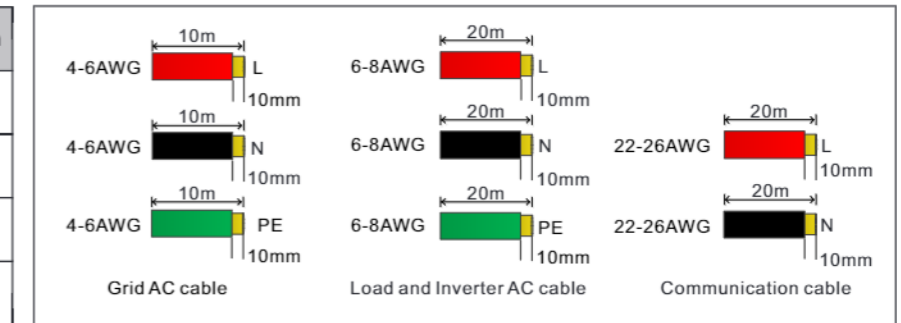

3.1 Wiring instructions

3.1.1 Connecting SYN 100-XH-30 to the Grid

1. Remove the two screws on the upper cover of the SYN 100-XH-30 to open the upper cover, and do not remove the cover inside the machine.
2. Twist the plastic cover printed with "Grid" counterclockwise, remove the five waterproof plugs, and reserve five holes.
3. Route the five power grid cables (L1/L2/L3/N/PE) through the five holes and connect them to the power grid input terminals and the ground copper bar. Screw torques for tightening the power grid terminals and ground terminals are shown in the following table.
4. Finally, fasten the plastic cover clockwise. The wiring method is shown in Figure 3.

	Screw torque
Power grid terminals	26.5 to 31 in*lbs
Ground terminal	13 in*lbs

Note: PE cables need to be crimped with the O-type terminal in the accessory bag, as shown in Figure 2.

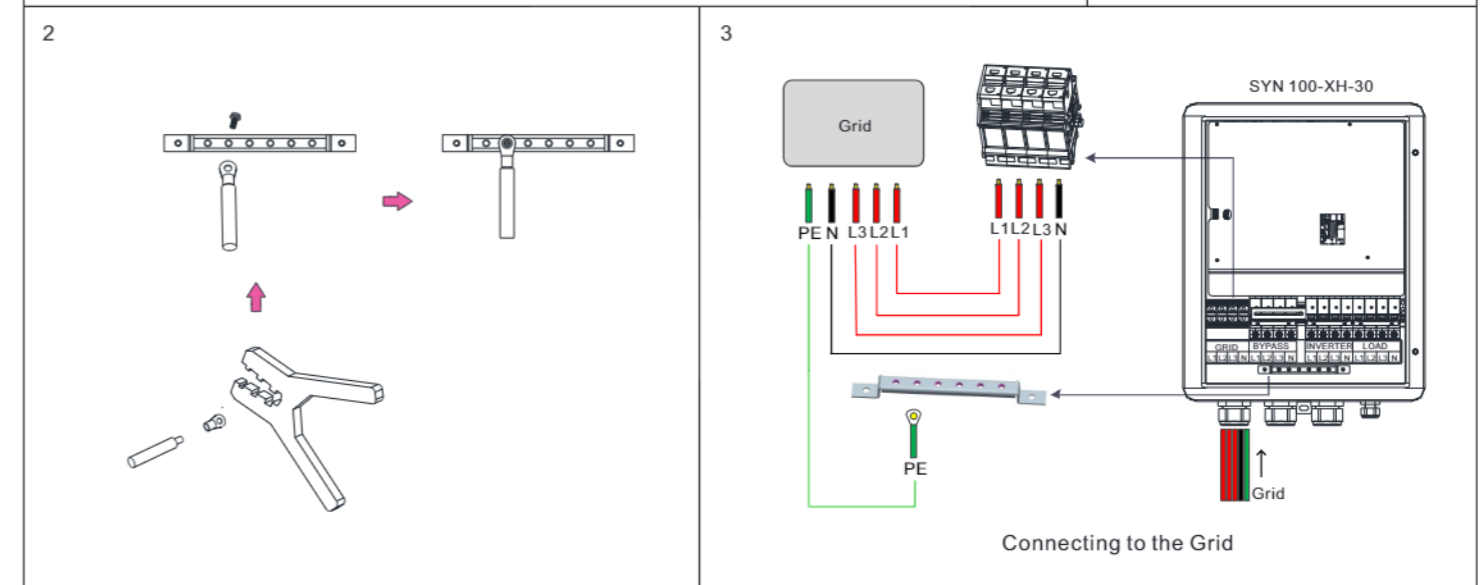

3.1.2 Connecting SYN 100-XH-30 to the Inverter

When connecting the SYN 100-XH-30 to the XH Inverter, we need to connect the AC power cables and the communication cables.

3.1.2.1 AC power cable connection:

1. Twist the plastic cover printed with "Inverter" counterclockwise; remove the five waterproof plugs, and reserve five holes.
2. Route the five cables of the inverter (L1/L2/L3/N/PE) through the five holes, connect the cables to the inverter breaker terminals (L1/L2/L3/N) and the ground copper bar. Screw torques for tightening the inverter breaker terminals and ground terminals are shown in the following table.
3. Finally, fasten the plastic cover clockwise. The wiring method is shown below:

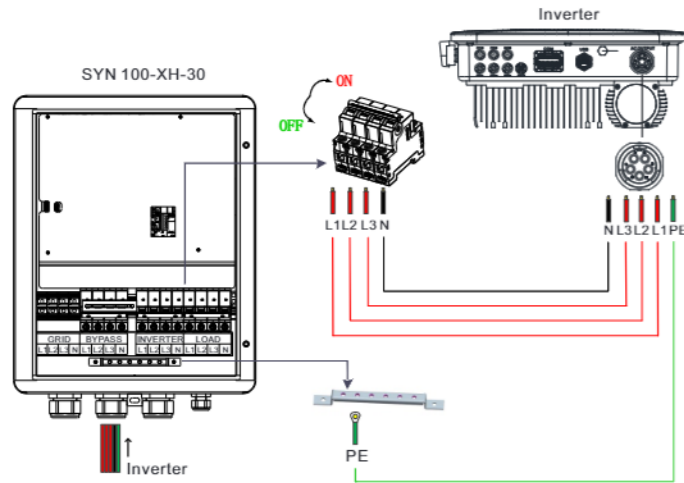

Connecting the AC cables to the XH Inverter

	Screw torque
Inverter circuit breaker terminals	17.5 in*lbs
Ground terminal	13 in*lbs

3.1.2.2 Communication cable connection:

1. Twist the plastic cover printed with "COM" on the machine counterclockwise; remove the waterproof plug, and reserve one hole.
2. Route the two communication cables (A/B) (the twisted pair cable are recommend) and the two BOX EN cables (EN+/EN-) through the hole, connect them to the CN8 terminals on the control board, connect the other end of the cables to the COM terminals of the inverter, and tighten the screws. The following table lists the corresponding terminal pins. The wiring method is shown as follows:

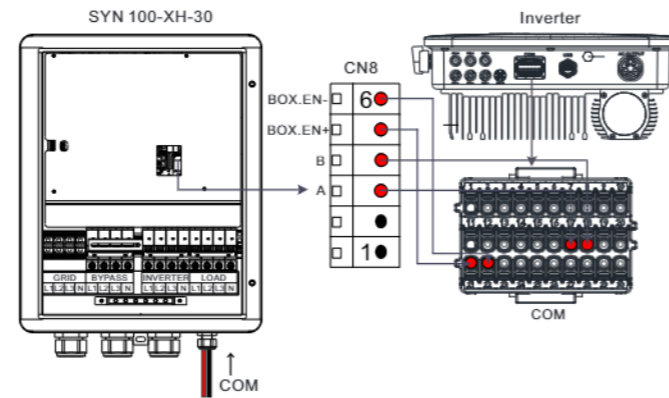

Connecting the communication cables to the XH Inverter

COM Port	XH Inverter COM	SYN 100-XH-30 COM	Control Board
RS485 A	PIN 17	PIN 3	CN8
RS485 B	PIN 18	PIN 4	
BOX.EN+	PIN 21	PIN 5	
BOX.EN-	PIN 22	PIN 6	

3.1.3 Connecting SYN 100-XH-30 to the load

1. Twist the plastic cover printed with "Load" counterclockwise, remove the five waterproof plugs, and reserve three holes.
2. Route the five load cables (L1/L2/L3/N/PE) through the five holes, connect them to the load circuit breaker terminals (L1/L2/L3/N) and ground copper bar. Screw torques for tightening the load breaker terminals and ground terminals are shown on the right:
3. Finally, fasten the plastic cover clockwise. The wiring method is shown on the right:

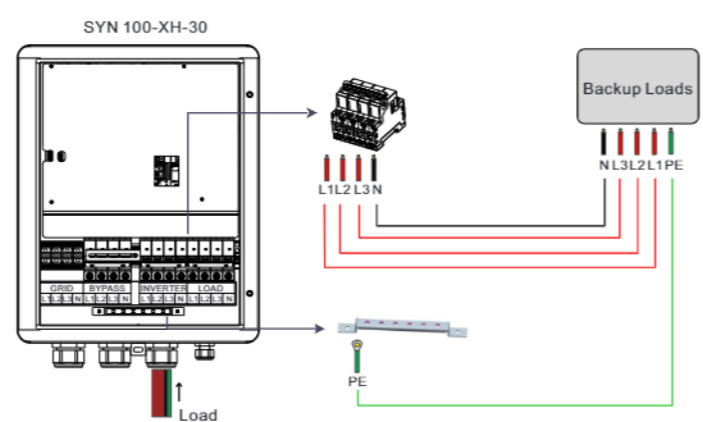

Connecting to the AC Loads

	Screw torque
Load breaker terminal	17.5 in*lbs
Ground terminal	13 in*lbs

4. Indicator Description

System state	indicator status	
	Green	Red
On-grid Mode	On	Off
Back-up Mode	Blinking, on 1s, off 1s	Off
No communication with the inverter	Off	Blinking, on 1s, off 1s
System fault	Off	On
Firmware upgrade	When the upgrade starts, the yellow light is on or off for 10-20s, and then the yellow light blinks at intervals of 2s (on for 1 second and off for 1 second).	

5. System startup and shutdown operations

5.1 To start the system, please perform the following steps:

1. Turn on the DC switch of the battery. For details, please refer to the battery manual.
2. Turn on the DC switch of the inverter. For details, please refer to the XH inverter manual.
3. Turn on the inverter input breaker of the SYN 100-XH-30, and observe whether the inverter and battery indicators are displayed. If yes, move on to the next step. If the indicators are not displayed, it means that there is no mains supply. You need to press and hold the POWER button of the battery for a long period to wake up the battery. Please refer to the battery installation manual.
4. If the backup box is connected, please enable the Backup Box via inverter settings. For details, please refer to the Chapter 9.3.3 in the manual of Inverter.
5. Turn on the grid switch.
6. If the SYN 100-XH-30 indicator light turns green after completing the preceding steps, it indicates that the SYN 100-XH-30 is functioning properly.
7. If you cannot power on the system with the instructions provided above, please contact Growatt.

5.2 To shut down the system, please perform the following steps:

1. Disconnect the Inverter input breaker and the load input breaker on the SYN 100-XH-30 and then disconnect the power grid switch.
2. Turn off the DC switch of the inverter.
3. Turn off the DC switch of the battery.
4. Wait for a while and all the indicators of the inverter, the battery, and the SYN 100-XH-30 will go off, indicating that the system is powered off completely.

6. Transfer to the bypass mode manually

When SYN 100-XH-30 is faulty, it cannot transfer to the bypass mode automatically. In order to ensure uninterrupted power supply to loads, the bypass mode can be initiated manually.

The operation is as follows:

1. Shut down the entire system. For details, please refer to section 5.2.
2. Use a Phillips screwdriver to loosen the limit switch screws on the power bypass switch.
3. Slide the firmware to one end of the inverter switch.
4. Tighten the screws on the limit switch with a torque of 10.5 in* lbs / 1.2 N*m. Turn on the power bypass switch. The operation instructions are shown below.
5. Power on the entire system. For details, please refer to section 5.1.

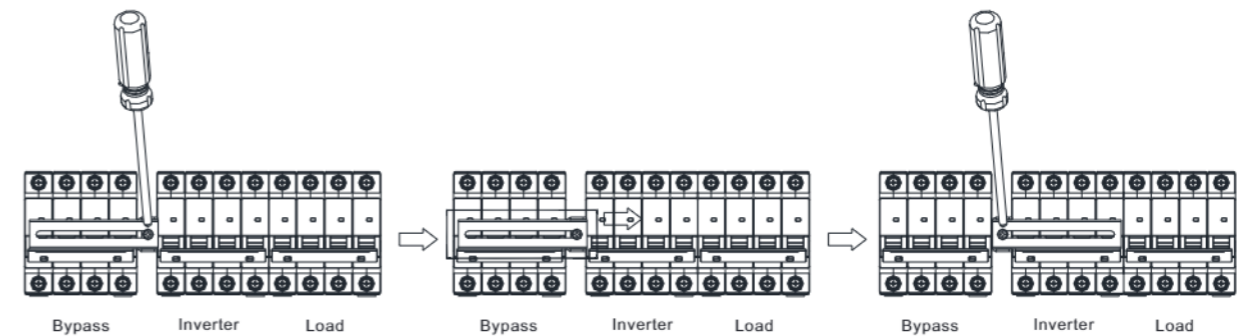

7. Service and contact

Shenzhen Growatt New Energy CO.,LTD
4-13/F, Building A, Sino-German (Europe) Industrial Park,
Hangcheng Ave, Bao'an District, Shenzhen, China

T +86 0755 2747 1942
E service@ginverter.com
W www.ginverter.com



Download Manual



Growatt New Energy

GR-UM-312-A-00