

Farola Solar LED Minlight para Alumbrado Público 60W

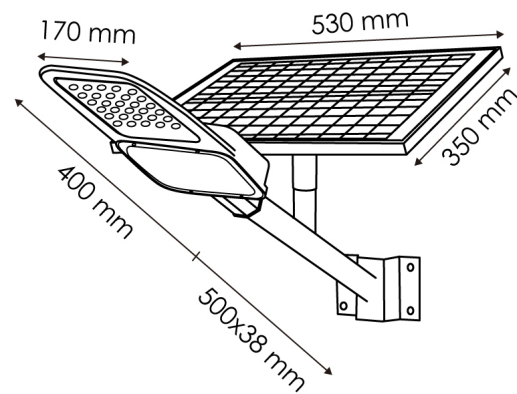

Garantía / Warranty

Garantía de Producto 3 Años

Tabla de Referencias / Reference Table

LM6371 - 6000k

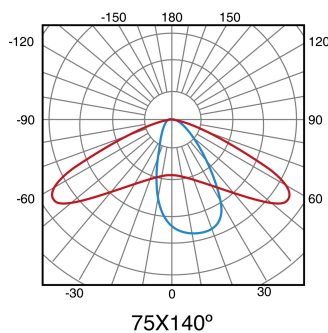

Características / Technical Attributes

Marca	M LEDME
Vatios	60
Fuente lumínica	Bridgelux
Acabado	Gris
Luminosidad	4200
Temperatura de trabajo	-30°C ~ + 50°C
Angulo	140°X75°
Vida útil	40000
Proteccion	IP65
Bateria	3.2V 15.000mAH
Dimensión	530X900 mm
Material	Aluminio/PMMA
CRI	75
Tiempo de carga	6-8 Horas
Tiempo de uso	8-10 Horas
Sensor	Sensor Crepuscular
Incluye	Control remoto
Regulable	Si
Garantía	3
Temperatura de color	6500

